

# NANO-D CONNECTORS

## NANO-D GENERAL INFORMATION

- Nano-D connectors introduction . . . . . 206
- REACH & RoHS compliance . . . . . 207
- Nano-D glossary of terms . . . . . 208
- Nano-D general characteristics . . . . . 209
- Nano-D contact arrangements
  - Contact arrangements for dual row Nano-D connectors . . . . . 210*
  - Contact arrangements for single row Nano-D connectors . . . . . 212*
- Nano-D wire codes . . . . . 214
- Nano-D colour codes . . . . . 215
- Nano-D jumper wiring
  - Jumper wiring for dual row Nano-D connectors . . . . . 216*
  - Jumper wiring for single row Nano-D connectors . . . . . 217*
- Nano-D panel cutouts . . . . . 218

## DUAL ROW NANO-D CONNECTORS

### RECTANGULAR CONNECTORS FOR CABLES

- Dual row pigtail & jumper . . . . . 220
- EMI range: Dual row pigtail & jumper . . . . . 222

### PCB RECTANGULAR CONNECTORS

- BS (Board Straight) type - 0.050" pitch receptacles . . . . . 224
- BS (Board Straight) type - 0.050" pitch plugs . . . . . 226
- CBR (Condensed Board Right Angle) type - 0.050" pitch receptacles . . . . . 228
- CBR (Condensed Board Right Angle) type - 0.050" pitch plugs . . . . . 230
- SMV (Surface Mount Vertical) type - 0.025" pitch receptacles . . . . . 232
- SMV (Surface Mount Vertical) type - 0.025" pitch plugs . . . . . 234
- SMH (Surface Mount Horizontal) type - 0.025" pitch receptacles . . . . . 236
- SMH (Surface Mount Horizontal) type - 0.025" pitch plugs . . . . . 238
  - PCB layout for BS type . . . . . 240*
  - PCB layout for CBR type . . . . . 242*
  - PCB layout for SMV type . . . . . 244*
  - PCB layout for SMH type . . . . . 248*

## SINGLE ROW NANO-D CONNECTORS

### RECTANGULAR CONNECTORS FOR CABLES

- Single row pigtail & jumper . . . . . 254

### PCB RECTANGULAR CONNECTORS

- BS (Board Straight) type - 0.050" pitch receptacles . . . . . 256
- BS (Board Straight) type - 0.050" pitch plugs . . . . . 258
- CBR (Condensed Board Right Angle) type - 0.050" pitch receptacles. 260
- CBR (Condensed Board Right Angle) type - 0.050" pitch plugs . . . . . 262
- SMV (Surface Mount Vertical) type - 0.025" pitch receptacles. . . . . 264
- SMV (Surface Mount Vertical) type - 0.025" pitch plugs . . . . . 266
- SMH (Surface Mount Horizontal) type - 0.025" pitch receptacles. . . . . 268
- SMH (Surface Mount Horizontal) type - 0.025" pitch plugs . . . . . 270
- *PCB layout for BS type* . . . . . 272
- *PCB layout for CBR type* . . . . . 274
- *PCB layout for SMV type* . . . . . 276
- *PCB layout for SMH type* . . . . . 278

### HIGH DENSITY CONNECTORS

- High density connectors . . . . . 282
- General characteristics . . . . . 283
- Pigtail connectors . . . . . 284
- PCB connectors . . . . . 286
- *Board straight type (BS) 0.050" pitch dimensions.* . . . . . 287
- *PCB layout for BS type* . . . . . 288
- *Condensed board right (CBR) 0.050" pitch dimensions.* . . . . . 289
- *PCB layout for CBR type* . . . . . 290

# GENERAL INFORMATION

- Nano-D connectors introduction . . . . . 206
- REACH & RoHS compliance . . . . . 207
- Nano-D glossary of terms . . . . . 208
- Nano-D general characteristics . . . . . 209
- Nano-D contact arrangements
  - Contact arrangements for dual row Nano-D connectors* . . . . . 210
  - Contact arrangements for single row Nano-D connectors* . . . . . 212
- Nano-D wire codes . . . . . 214
- Nano-D colour codes . . . . . 215
- Nano-D jumper wiring
  - Jumper wiring for dual row nano-D connectors* . . . . . 216
  - Jumper wiring for single row nano-D connectors* . . . . . 217
- Nano-D panel cutouts . . . . . 218



# NANO-D CONNECTORS

## 0.635 mm (.025") CONTACT SPACING

In addition to the standard range of Micro-D connectors and assemblies, AXON' is able to offer Nano-D connectors and assemblies based on the highly reliable Twist Pin contact technology. Such solutions are ideal for applications including aerospace, military, industrial, medical or off-shore which require extreme miniaturisation, space or weight saving and reliability. AXON' Nano-D connectors meet the requirements of MIL-DTL-32139.

### ► Different configurations

AXON's range of Nano-D connectors is available in several different configurations:

- Nano-D rectangular connectors for cables.
- Nano-D rectangular connectors for PCBs.
- EMI versions.
- High density Micro-D connectors.

### ► Characteristics

- 0.635 mm (.025") contact spacing (double the density of a Micro-D).
- Number of ways: 9, 15, 21, 25, 31, 37 and 51.
- Single or double row.
- High reliability twist pin contacts.
- Metal shell construction with captivated hardware.

AXON' has also developed custom designed Nano-D connectors:

- High density circular Nano-D connectors.
- Single row Nano-D strip connectors.

Special Nano-D connectors available on request.

# REACH & RoHS COMPLIANCE

## ▶ RoHS compliance

AXON' CABLE has been pro-actively implementing measures for many years to ensure compliance with the European Directive 2011/65/EU which came into force on 21<sup>st</sup> July 2011. The Directive prohibits the use of Hazardous Substances such as lead, mercury, hexavalent chromium, cadmium, bromine compounds (PBB and PBDE) and various phthalates. It relates to all components of products which are used in the manufacture of electrical and electronic equipment.

As a cable and connector manufacturer, AXON' has taken actions to ensure compliance with directive 2000/53/EC applicable since 21<sup>st</sup> October 2000.

### COMPONENT SPECIFIC RoHS COMPLIANCE

COMPONENT	MATERIAL	FINISH	RoHS STATUS
<b>PIN CONTACT (TWIST PIN)</b>	PRECIOUS GOLD ALLOY	N/A	RoHS Compliant
<b>SOCKET CONTACT</b>	PRECIOUS GOLD ALLOY	N/A	RoHS Compliant
	BRASS	GOLD	
	COMERCIAL BRONZE	GOLD	
<b>PLASTIC SHELL</b>	LIQUID CRYSTAL POLYMER	N/A	RoHS Compliant
<b>METAL SHELL</b>	ALUMINIUM ALLOY TYPE 6061	ELECTROLESS NICKEL	RoHS Compliant
	STAINLESS STEEL 300 SERIES	PASSIVATION	RoHS Compliant
	TITANIUM	N/A	RoHS Compliant
<b>PLASTIC INSERT / PCB TRAY</b>	LIQUID CRYSTAL POLYMER	N/A	RoHS Compliant
<b>HARDWARE</b>	STAINLESS STEEL 300 SERIES	PASSIVATION	RoHS Compliant
<b>PCB TERMINATION</b>	COPPER BASE ALLOY	GOLD	RoHS Compliant
<b>ENCAPSULANT</b>	EPOXY RESIN 150°C VERSION	N/A	RoHS Compliant
	EPOXY RESIN 200°C VERSION	N/A	RoHS Compliant

## ▶ Application of REACH

The new EU regulation on the Registration, Evaluation, Authorisation and restriction of Chemicals (REACH) came into force in June 2007. The regulation concerns the authorised use of chemicals. It requires manufacturers and importers to register substances and their use with the European Chemical Agency (ECHA).

AXON' CABLE is known as a "downstream user" with respect to the REACH regulation, and a manufacturer of "Articles". AXON' CABLE products are not intended to release any undesired substance under normal and reasonable operations of use.

To this day AXON' CABLE have not identified any component containing any SVHC in their product range.

## GLOSSARY OF TERMS

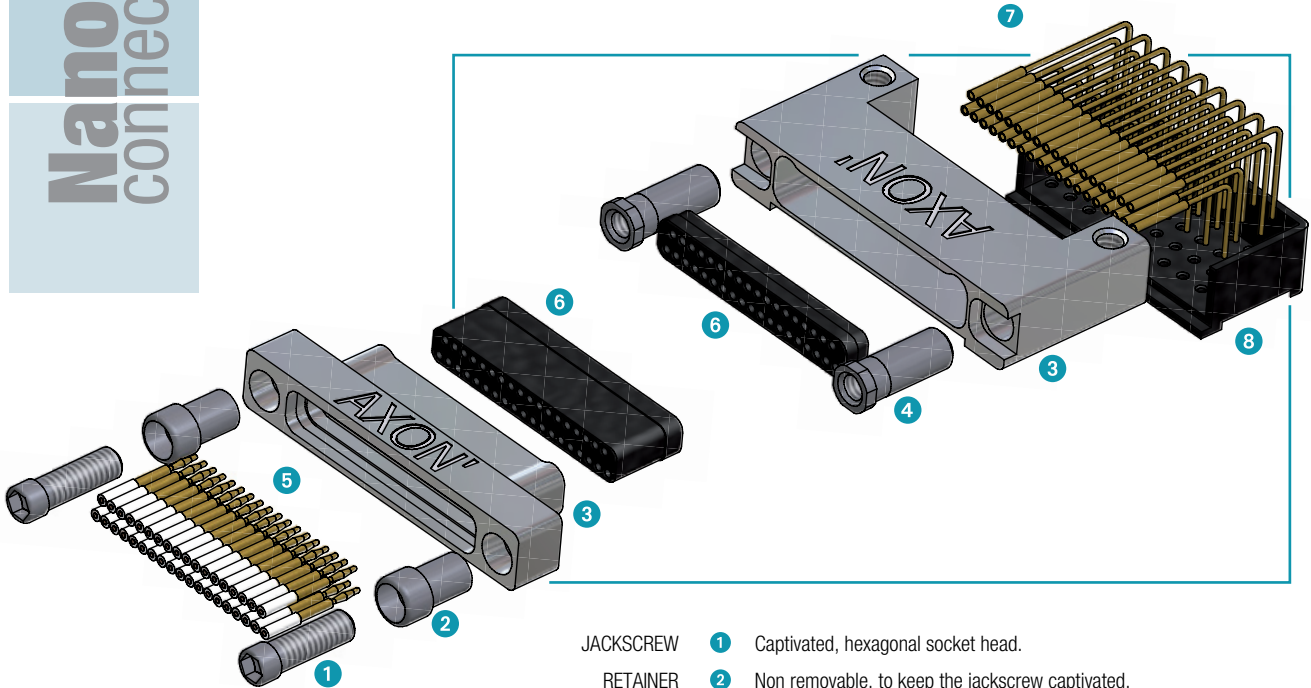

- JACKSCREW 1 Captivated, hexagonal socket head.
- RETAINER 2 Non removable, to keep the jackscrew captivated.
- SHELL 3 Metal connector body.
- THREADED INSERT 4 Non removable, mates with jackscrew.
- TWIST PIN 5 Male contact, fitted to plug connector.
- INSERT 6 Moulded insulation housing, separating each connection.
- SOCKET 7 Female contact, fitted to socket connector (also known as socket).
- TRAY 8 Junction box used for PCB connectors only.

- Standard connector ● Manufactured to the standard dimensions and specifications.
- Special connector ● A standard connector modified to meet specific requirements.
- Custom made connector ● Designed to meet specific customer requirements.
- Connector saver ● Used to reduce wear and tear on equipment and systems while testing.
- CBR connector ● Condensed Board Right Angle connector.
- BS connector ● Board Straight connector.
- SMV connector ● Surface Mount Vertical connector.
- SMH connector ● Surface Mount Horizontal connector.
- Pigtail connector ● Connector with insulated or uninsulated wires.
- Cord ● Cable harness with 2 connectors only.
- Jumper/ Extension cord ● Cord with 1 plug and 1 receptacle connector of the same number of ways.
- Harness ● Multi-branched cable assembly.
- LCP ● Liquid Crystal Polymer.
- Potting ● Epoxy compound used as an encapsulant.

# GENERAL CHARACTERISTICS

per MIL-DTL-32139\*

AXON's range of Nano-D connectors which is covered by the MIL-DTL-32139\* standard, is ideally suited to equipment and applications where weight, miniaturisation and long term performance are required. It is available in 7 contact arrangements (9 to 51 contacts) for rectangular Nano-D connectors.

## ▶ Electrical & mechanical characteristics

CHARACTERISTIC	SPECIFICATION	TEST METHOD
CURRENT RATING	1 A max.	EIA-364-70
CONTACT RESISTANCE	71 mΩ max.	EIA-364-06
INSULATION RESISTANCE	5000 MΩ min. @ 100 V <sub>dc</sub>	EIA-364-21
DIELECTRIC WITHSTANDING VOLTAGE - SEA LEVEL 0 m - ALTITUDE 21 km (70,000 ft)	250 V <sub>ac</sub> 100 V <sub>ac</sub>	EIA-364-20
CONTACT ENGAGING AND SEPARATION FORCE	141 g max. (5 oz) 11 g min. (0.4 oz)	EIA-364-37
CONNECTOR MATING AND DE-MATING FORCE	198 g (7 oz) x number of contacts max.	EIA-364-13
CONTACT RETENTION	0.9 kg (2 lbs) for 5 seconds min.	EIA-364-29
DURABILITY	200 mating cycles min.	EIA-364-09
TEMPERATURE RANGES - STANDARD - HIGH TEMP	-55°C / +150°C -55°C / +200°C	
VIBRATION	20 g's - No discontinuity >1μs	EIA-364-28 - TEST CONDITION IV
SHOCK	100 g's - No discontinuity >1μs	EIA-364-27 - TEST CONDITION G
SALT SPRAY	48 hours	EIA-364-26 - TEST CONDITION B
HUMIDITY	Insulation resistance > 1MΩ	EIA-364-31 - TEST CONDITION B (EXCLUDING STEPS 7A & 7B)**

## ▶ Material & Finish

COMPONENT	MATERIAL	FINISH
MALE CONTACT (TWIST PIN)	PRECIOUS GOLD ALLOY IN ACCORDANCE WITH ASTM-B-477 OR 541 OR 562	NONE
FEMALE CONTACT	PRECIOUS GOLD ALLOY IN ACCORDANCE WITH ASTM-B-477 OR 541 OR 562	NONE
	COMMERCIAL BRONZE IN ACCORDANCE WITH ASTM-B-135, B-140/140M, B-372 OR B-587	GOLD PLATING IN ACCORDANCE WITH ASTM-B488, TYPE II, CLASS 1 (1.27μm MIN. (0.00005")), CODE C OVER NICKEL UNDERPLATE IN ACCORDANCE WITH SAE-AMS-QQ-N-290, CLASS 2 (1.27μm (0.00005")) TO 3.81μm (0.00015"))
	BRASS IN ACCORDANCE WITH ASTM-B-453 OR 453M OR 16 OR 16M	
METAL SHELL	ALUMINIUM ALLOY, TYPE 6061 IN ACCORDANCE WITH SAE-AMS-QQ-A-200/8 OR ASTM-B-209	ELECTROLESS NICKEL PLATING IN ACCORDANCE WITH SAE-AMS-2404, CLASS 4.
	TITANIUM IN ACCORDANCE WITH SAE-AMS-T-9046	NONE
	STAINLESS STEEL IN ACCORDANCE WITH SAE-A-276 OR 581 OR 581M OR 582 OR 582M	PASSIVATION IN ACCORDANCE WITH SAE-AMS2700
INSERT/ PCB TRAY	LIQUID CRYSTAL POLYMER, 30% LOADED GLASS FIBRE POLYESTER 94VO, IN ACCORDANCE WITH MIL-M-24519 (200°C)	
HARDWARE	STAINLESS STEEL, 300 SERIES	PASSIVATION IN ACCORDANCE WITH SAE-AMS2700
ENCAPSULANT	EPOXY RESIN	
INSULATED WIRE	PTFE INSULATED SILVER PLATED COPPER IN ACCORDANCE WITH NEMA-HP3	
UNINSULATED WIRE	GOLD PLATED SOLID COPPER WIRE IN ACCORDANCE WITH A-A-59551 OR GOLD PLATED SOLID COPPER BASED ALLOY IN ACCORDANCE WITH ASTM-B-194	GOLD PLATING IN ACCORDANCE WITH ASTM-B488, TYPE II, CLASS 1 (1.27μm MIN. (0.00005")), CODE C OVER NICKEL UNDERPLATE IN ACCORDANCE WITH SAE-AMS-QQ-N-290, CLASS 2 (1.27μm (0.00005")) TO 3.81μm (0.00015"))

\*: ISSUE A AMENDMENT 4 AT THE TIME OF GOING TO PRESS

\*\* : ACCORDING TO MIL-DTL-32139

# CONTACT ARRANGEMENTS (DUAL ROW)

► Mating face of male rectangular connector

- 0.635 mm (.025") contact spacing.
- 1.016 mm (.040") spacing between rows.

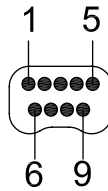

9 CONTACTS

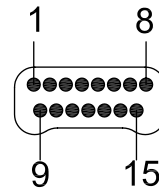

15 CONTACTS

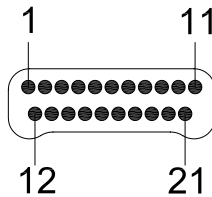

21 CONTACTS

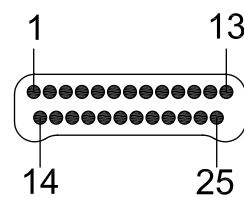

25 CONTACTS

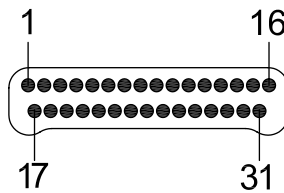

31 CONTACTS

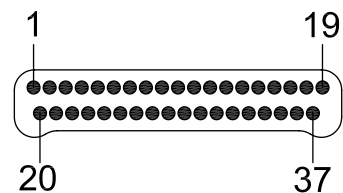

37 CONTACTS

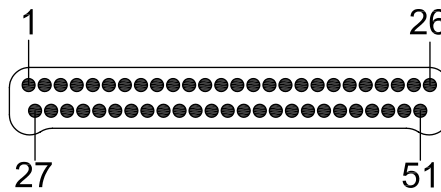

51 CONTACTS

OTHER CONTACT ARRANGEMENTS AVAILABLE ON REQUEST



# CONTACT ARRANGEMENTS (DUAL ROW)

► Mating face of female rectangular connector

- 0.635 mm (.025") contact spacing.
- 1.016 mm (.040") spacing between rows.

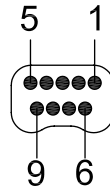

9 CONTACTS

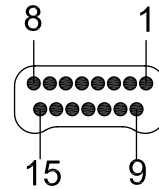

15 CONTACTS

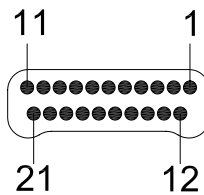

21 CONTACTS

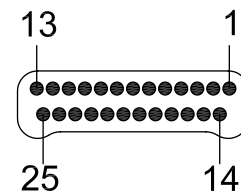

25 CONTACTS

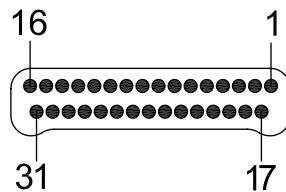

31 CONTACTS

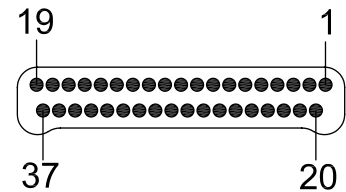

37 CONTACTS

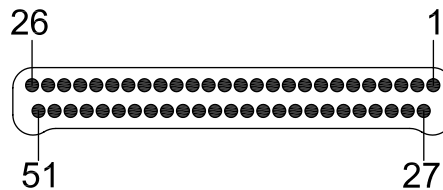

51 CONTACTS

# CONTACT ARRANGEMENTS (SINGLE ROW)

▶ Mating face of male rectangular connector

0.635 mm (.025") contact spacing.

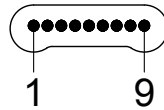

9 CONTACTS

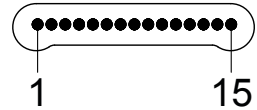

15 CONTACTS

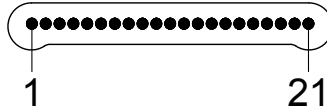

21 CONTACTS

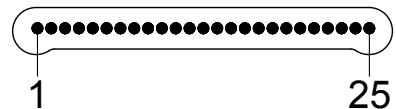

25 CONTACTS

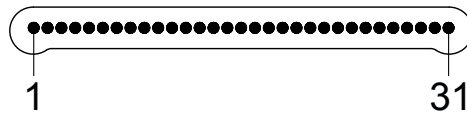

31 CONTACTS

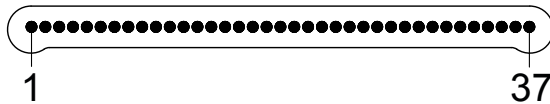

37 CONTACTS

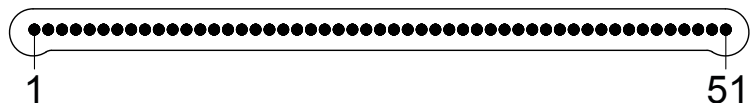

51 CONTACTS

OTHER CONTACT ARRANGEMENTS AVAILABLE ON REQUEST

# CONTACT ARRANGEMENTS (SINGLE ROW)

► Mating face of female rectangular connector

0.635 mm (.025") contact spacing.

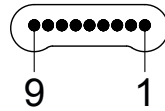

9 CONTACTS

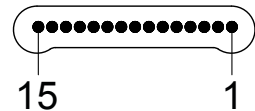

15 CONTACTS

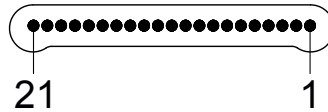

21 CONTACTS

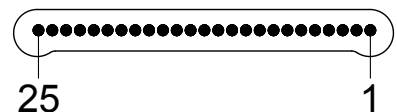

25 CONTACTS

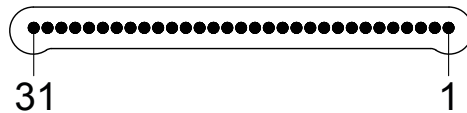

31 CONTACTS

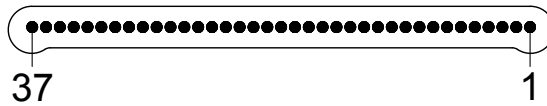

37 CONTACTS

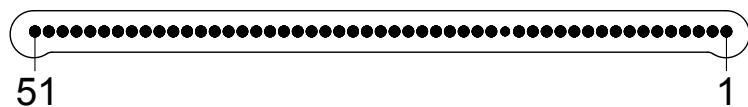

51 CONTACTS

# WIRE CODES

Nominal dimensions are used throughout this chapter.

## ► Solid uninsulated wires

WIRE CODE	WIRE DESIGNATION	WEIGHT (g/m)	CONDUCTOR					
			MATERIAL	AWG	CONSTRUCTION mm (inch)	Ø mm (inch)	AREA mm <sup>2</sup> (sq in)	RESISTANCE Ω/100m (Ω/1000ft)
G	GPC3001	0.45	GOLD PLATED COPPER	30	1x0.254 1x0.010	0.254 .010	0.051 .00008	34.1 103.8

## ► Insulated wires

WIRE CODE	WIRE DESIGNATION	WEIGHT (g/m)	CONDUCTOR						INSULATION		TEMPERATURE RATING	VOLTAGE RATING
			MATERIAL	AWG	CONSTRUCTION mm (inch)	Ø mm (inch)	AREA mm <sup>2</sup> (sq in)	RESISTANCE Ω/100m (Ω/1000ft)	MATERIAL	Ø mm (inch)		
1	ET 3007 (ONLY FOR ND1A & ND2A SERIES)	1.50	SPC*	30	7x0.102 7x.0040	0.304 .012	0.057 .000882	31 94.5	EXTRUDED PTFE	0.62 .024	-90°C/+200°C	250 V <sub>ac</sub>
1	UT 3007 (ONLY FOR MDHDA SERIES)	0.85	SPC*	30	7x0.102 7x.0040	0.304 .012	0.057 .000882	31 94.5	EXTRUDED PTFE	0.50 .020	-90°C/+200°C	160 V <sub>ac</sub>
2	ET 3207	1.20	SPC*	32	7x0.079 7x.0031	0.237 .009	0.034 .00005	52 158.5	EXTRUDED PTFE	0.57 .022	-90°C/+200°C	250 V <sub>ac</sub>
3	ET 3407	1.00	SPC*	34	7x0.063 7x.0025	0.189 .007	0.022 .00003	95 289.6	EXTRUDED PTFE	0.50 .020	-90°C/+200°C	250 V <sub>ac</sub>
4	ET 3607	0.80	SPC*	36	7x0.050 7x.0020	0.150 .006	0.014 .00006	150 457	EXTRUDED PTFE	0.48 .019	-90°C/+200°C	250 V <sub>ac</sub>

\*: SILVER PLATED COPPER

# COLOUR CODES

## ► Colour codes F and L

All the wires have the same colour.  
Available with all wire types.

COLOUR CODE	COLOUR
F	YELLOW
L	WHITE

Other colours available on request.

## ► Colour code W

Also called 10 colour repeat (10 colours repeated in sequence)  
as per MIL-DTL-32139. Available with all wire types.

PIN NUMBER	MIL-STD-681 NUMBER	COLOUR
1	0	BLACK
2	1	BROWN
3	2	RED
4	3	ORANGE
5	4	YELLOW
6	5	GREEN
7	6	BLUE
8	7	VIOLET
9	8	GREY
10	9	WHITE
11	0	BLACK
12	1	BROWN
13	2	RED
14	3	ORANGE
15	4	YELLOW
16	5	GREEN
17	6	BLUE
18	7	VIOLET
19	8	GREY
20	9	WHITE
21	0	BLACK

# Nano-D connectors

## JUMPER WIRING (DUAL ROW)



▲ NANO-D - JUMPER

### DIRECT WIRING

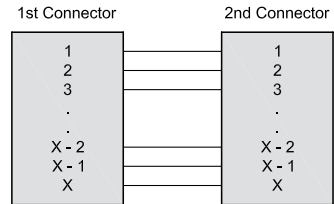

X : Number of contacts

### DIRECT WIRING

Direct Wiring is where every pin number is connected to the same pin number at the other end, e.g. pin 1 to pin 1, pin 2 to pin 2, and so on. If the two connectors are not of the same gender (i.e. one male, one female) this will result in physically straight or flat wiring with no crossovers. This is therefore the normal convention with opposing gender connectors.

### INDIRECT WIRING

Indirect Wiring is usually requested where both connectors on the jumper are of the same gender (i.e. both male or both female). In this case, if Direct Wiring was chosen it would result in many physical cross-overs of the wires (crossing from the leftmost pin on the top row to the rightmost, and the same on the bottom row). Indirect Wiring ensures that the physical position of the wires remains straight or flat, i.e. the leftmost pin on the top row of connector 1 will go to the leftmost pin on the top row of connector 2, and so on.

### 9 WAY INDIRECT WIRING

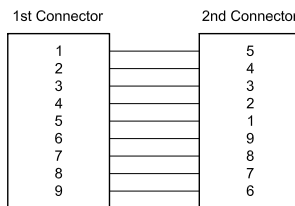

### 15 WAY INDIRECT WIRING

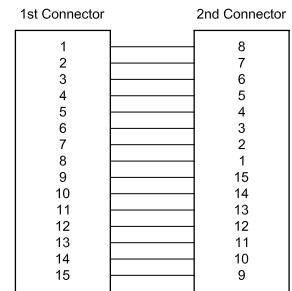

### 21 WAY INDIRECT WIRING

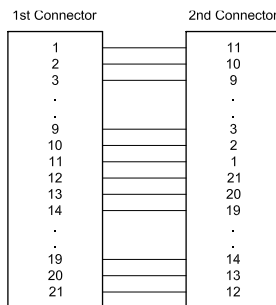

### 25 WAY INDIRECT WIRING

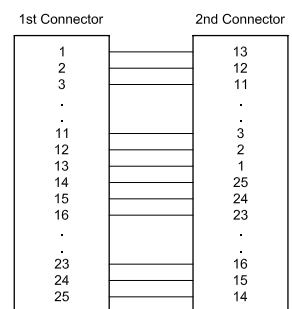

### 31 WAY INDIRECT WIRING

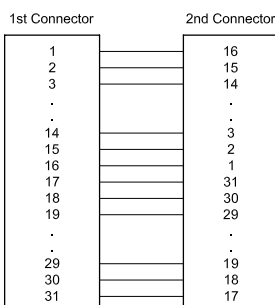

### 37 WAY INDIRECT WIRING

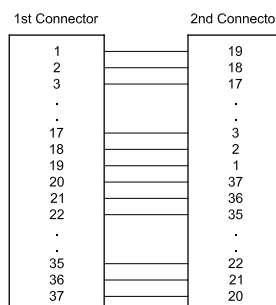

### 51 WAY INDIRECT WIRING

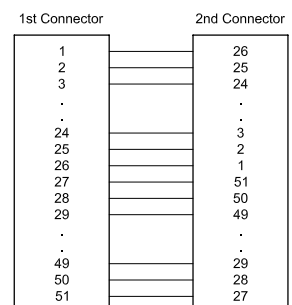

# JUMPER WIRING (SINGLE ROW)

## DIRECT WIRING

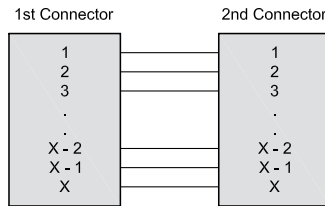

X : Number of contacts

## INDIRECT WIRING

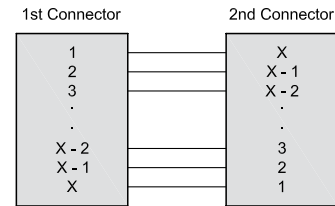

X : Number of contacts

Direct Wiring is where every pin number is connected to the same pin number at the other end, e.g. pin 1 to pin 1, pin 2 to pin 2, and so on. If the two connectors are not of the same gender (i.e. one male, one female) this will result in physically straight or flat wiring with no cross-overs. This is therefore the normal convention with opposing gender connectors.

Indirect Wiring is usually requested where both connectors on the jumper are of the same gender (i.e. both male or both female).

Indirect Wiring ensures that the physical position of the wires remains straight or flat, i.e. the leftmost pin of connector 1 will go to the leftmost pin of connector 2, and so on.

# PANEL CUTOUTS

## ► Dual row Rear Mount Nano-D connectors

Panel mount receptacle connector only (type M).

### 9 TO 51 CONTACTS

FIGURE 1  
REAR MOUNT

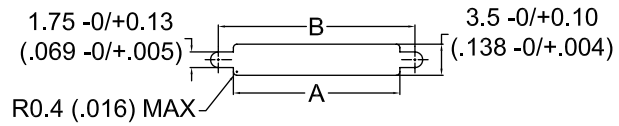

## ► Dimensions

Dimensions are in millimetres (inches)

LAYOUTS	A -0/ +0.1 (-0 /+.004)	B -0/ +0.1 (-0 /+.004)
9	9.90 .390	13.30 .523
15	11.80 .465	15.20 .598
21	13.71 .540	17.11 .673
25	14.98 .590	18.38 .723
31	16.88 .665	20.28 .800
37	18.79 .740	22.19 .873
51	23.23 .915	26.63 1.048



# DUAL ROW NANO-D CONNECTORS

## RECTANGULAR CONNECTORS FOR CABLES

- Dual row pigtail & jumper . . . . . 220
- EMI range: Dual row pigtail & jumper . . . . . 222

## PCB RECTANGULAR CONNECTORS

- BS (Board Straight) type - 0.050" pitch receptacles . . . . . 224
- BS (Board Straight) type - 0.050" pitch plugs . . . . . 226
- CBR (Condensed Board Right Angle) type - 0.050" pitch receptacles. 228
- CBR (Condensed Board Right Angle) type - 0.050" pitch plugs . . . . . 230
- SMV (Surface Mount Vertical) type - 0.025" pitch receptacles. . . . . 232
- SMV (Surface Mount Vertical) type - 0.025" pitch plugs . . . . . 234
- SMH (Surface Mount Horizontal) type - 0.025" pitch receptacles . . . . . 236
- SMH (Surface Mount Horizontal) type - 0.025" pitch plugs . . . . . 238
- *PCB layout for BS type* . . . . . 240
- *PCB layout for CBR type* . . . . . 242
- *PCB layout for SMV type* . . . . . 244
- *PCB layout for SMH type* . . . . . 248

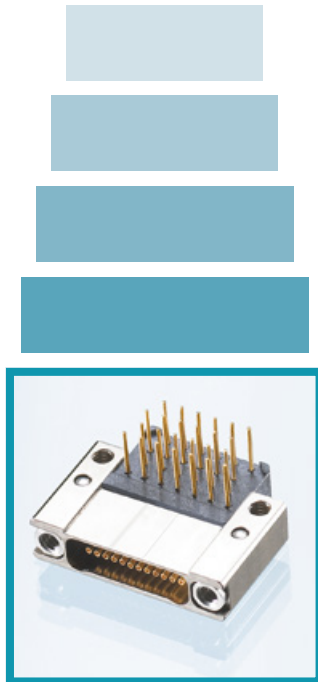

RECTANGULAR CONNECTORS FOR CABLES

# DUAL ROW PIGTAIL & JUMPER

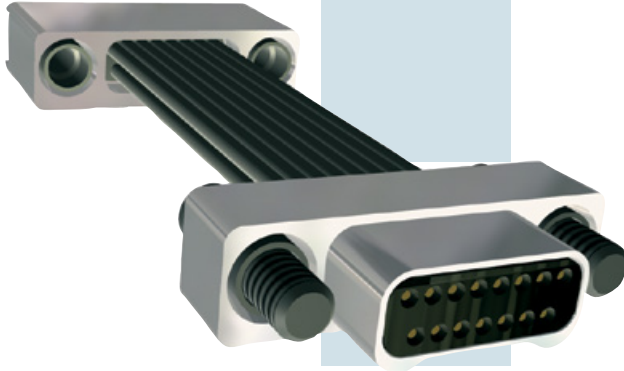

- Reliability for micro-miniature operating systems.
- High performance metal connector and PTFE wire.
- Panel mount available for receptacle connector.
  - Operating temperature: 150°C or 200°C.
  - 7 contact arrangements (9 to 51 contacts).

## IDENTIFICATION CODE

**ND2A 2 15 P S D 1 L 50 R P**

### SERIES

**ND2A:** Nano-D 2-row AXON®.

### CONNECTOR TYPE

**2:** Aluminium with electroless nickel plating and epoxy 150°C.  
**3:** Aluminium with electroless nickel plating and epoxy 200°C.  
 Other materials available on request (eg Titanium, Stainless Steel).

### NUMBER OF CONTACTS

**09, 15, 21, 25, 31, 37, 51.** Other versions available on request.

### 1st CONNECTOR TYPE

**P:** Plug connector.  
**S:** Receptacle connector.  
**M:** Panel mount receptacle connector.

### 2nd CONNECTOR TYPE

**P:** Plug connector.  
**M:** Panel mount receptacle connector.  
**W:** No second connector - free wires.

### CONNECTIONS (see jumper wiring on page 216)

**D:** Direct pin 1 to pin 1.  
**I:** Indirect (usual for plug-plug jumper).  
**X:** Pigtail.

### WIRE CODE

**1:** ET 3007, AWG 30, 7 strands, 250 V.  
**2:** ET 3207, AWG 32, 7 strands, 250 V.  
**3:** ET 3407, AWG 34, 7 strands, 250 V.  
**4:** ET 3607, AWG 36, 7 strands, 250 V.  
 Other versions available on request.

### COLOUR CODE

**L:** White.  
**F:** Yellow.  
**W:** 10 colour repeat.  
 See page 215 for colour code

### WIRE LENGTH (in cm)

Attention! Wire length in centimetres - (1cm = 10 mm = .394").

L	2 ≤ L ≤ 10	10 < L ≤ 100	L > 100
in cm (inches)	0.79 ≤ L ≤ 3.940	3.940 < L ≤ 39.40	39.40
TOLERANCE	-0 / +0.5	-0 / +3	-0 / +5
in cm (inches)	-0 / +0.200	-0 / +1.180	-0 / +1.970

### HARDWARE 1st CONNECTOR

**P:** Threaded hole #0-80 UNF (non removable jackposts, recommended for receptacles).  
**R:** Retractable short hex socket head jackscrews #0-80 UNF (semi-captivated, recommended for plugs).  
**L:** Short hex socket head jackscrews #0-80 UNF (captivated).  
**B:** No hardware.

### HARDWARE 2nd CONNECTOR

See above.  
**X:** Pigtail.

IN BOLD: FACTORY STANDARD

# DIMENSIONS

Dimensions are in millimetres (inches).

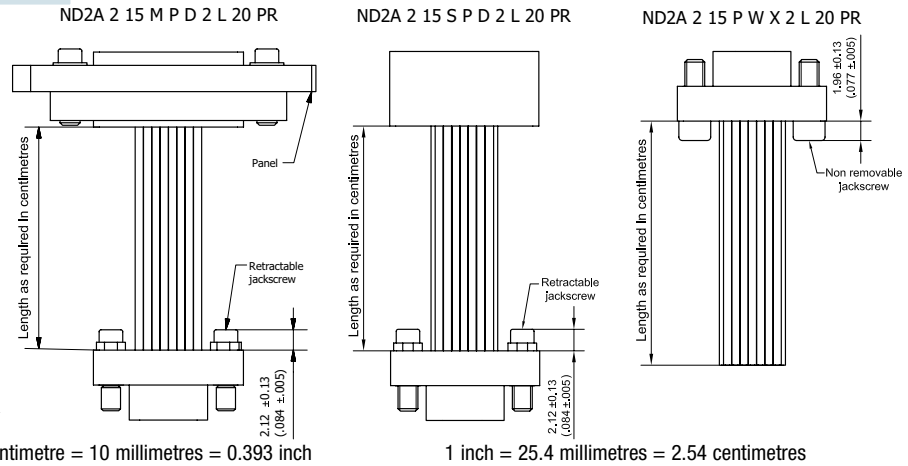

## PANEL MOUNT RECEPTACLE

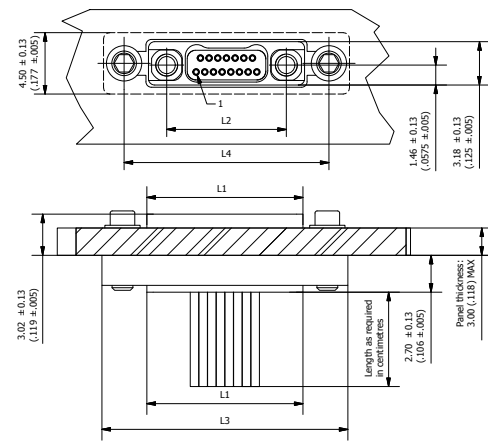

## RECEPTACLE

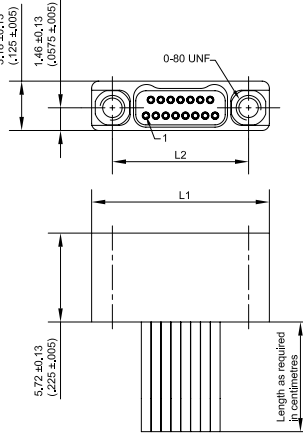

## PLUG

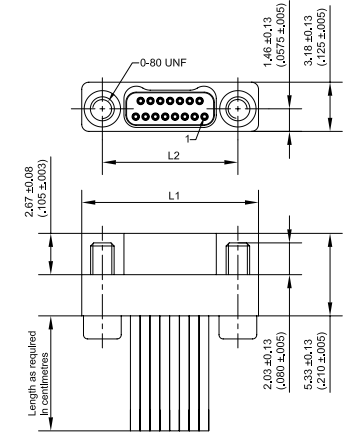

### SPECIFIC HARDWARE CONFIGURATION

Treaded holes #0-80 UNF for plug shell (code: P)

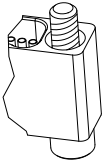
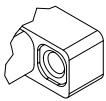

Jack screw #0-80 UNF for socket shell (code: R/L)

SHELL SIZE	L1 ±0.13 (±.005)	L2 ±0.13 (±.005)	L3 ±0.13 (±.005)	L4 ±0.13 (±.005)
9 P / 9 S	9.53 .375	6.86 .270	16.10 .634	13.10 .516
15 P / 15 S	11.43 .450	8.76 .345	18.00 .709	15.00 .591
21 P / 21 S	13.34 .525	10.67 .420	19.91 .784	16.91 .666
25 P / 25 S	14.61 .575	11.94 .470	21.18 .834	18.18 .716
31 P / 31 S	16.51 .650	13.84 .545	23.09 .909	20.08 .791
37 P / 37 S	18.42 .725	15.75 .620	24.99 .984	21.99 .866
51 P / 51 S	22.86 .900	20.19 .795	29.43 1.159	26.43 1.041

## SUMMARY OF CHARACTERISTICS

ELECTRICAL & MECHANICAL PERFORMANCE		MATERIAL & FINISH	
CURRENT RATING	1 A max.	SHELL	Aluminium Alloy 6061 or 300 series stainless steel or titanium alloy, see page 209 for finish
CONTACT RESISTANCE	71 mΩ max.	MOULDED INSULATOR	Liquid Crystal Polymer (LCP)
INSULATION RESISTANCE	5000 MΩ min. @ 100 Vdc	PIN CONTACT	Precious gold alloy
DIELECTRIC WITHSTANDING VOLTAGE	Sea level: 250 Vac Altitude 21 km (70,000 ft): 100 Vac	SOCKET CONTACT	Precious gold alloy
CONTACT ENGAGING FORCE	141 g max. (5 oz)	ENCAPSULANT	Epoxy resin
CONTACT SEPARATING FORCE	11 g min. (0.4 oz)	HARDWARE	300 series stainless steel, passivated
CONTACT RETENTION	0.9 kg (2 lbs)		
DURABILITY	200 mating cycles min.		
VIBRATION	20g's - No discontinuity > 1 μs		
SHOCK	100g's - No discontinuity > 1 μs		

RECTANGULAR CONNECTORS FOR CABLES

# EMI RANGE

## SHIELDED DUAL ROW PIGTAIL & JUMPER

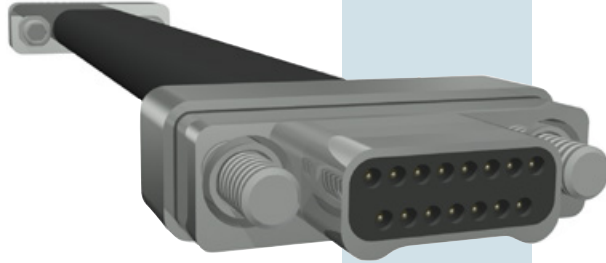

- Reliability for micro-miniature operating systems.
- High performance metal connector and PTFE wire.
  - Panel mount available for receptacle connector.
    - For ultra miniature EMI requirements.
      - 360° screen termination.
  - Operating temperature: 150°C or 200°C.
  - 7 contact arrangements (9 to 51 contacts).

### IDENTIFICATION CODE

**ND2A 2 15 P S EMI1 D 1 L 50 R P**

**SERIES**

**ND2A:** Nano-D 2-row AXON®.

**CONNECTOR TYPE**

**2:** Aluminium with electroless nickel plating and epoxy 150°C.  
**3:** Aluminium with electroless nickel plating and epoxy 200°C.  
 Other materials available on request (eg Titanium, Stainless Steel).

**NUMBER OF CONTACTS**

09, 15, 21, 25, 31, 37, 51. Other versions available on request.

**1st CONNECTOR TYPE**

**P:** Plug connector.

**S:** Receptacle connector.

**M:** Panel mount receptacle connector.

**2nd CONNECTOR TYPE**

**P:** Plug connector.

**M:** Panel mount receptacle connector.

**S:** Receptacle connector.

**W:** No second connector - free wires.

**EMI FAMILY**

**EMI1:** Shielded pigtail or harness, shield soldered to the backshell

**CONNECTIONS (see jumper wiring on page 216)**

**D:** Direct pin 1 to pin 1.

**I:** Indirect (usual for plug-plug jumper).

**X:** Pigtail.

**WIRE CODE**

**1:** ET 3007, AWG 30, 7 strands, 250 V.

**2:** ET 3207, AWG 32, 7 strands, 250 V.

**3:** ET 3407, AWG 34, 7 strands, 250 V.

**4:** ET 3607, AWG 36, 7 strands, 250 V.

Other versions available on request.

**COLOUR CODE**

**L:** White.

**F:** Yellow.

**W:** 10 colour repeat.

See page 215 for colour code.

**WIRE LENGTH (in cm)**

Attention! Wire length in centimetres - (1 cm = 10 mm = .394").

**HARDWARE 1st CONNECTOR**

**P:** Threaded hole #0-80 UNF (non removable jackposts).

**R:** Retractable short hex socket head jackscrews #0-80 UNF (semi-captivated).

**HARDWARE 2nd CONNECTOR**

See above.

**X:** Pigtail.

L	5 ≤ L ≤ 10	10 < L ≤ 100	L > 100
in cm (inches)	1.97 ≤ L ≤ 3.940	3.940 < L ≤ 39.40	39.40
TOLERANCE	-0 / +0.5	-0 / +3	-0 / +5
in cm (inches)	-0 / +0.200	-0 / +1.180	-0 / +1.970

IN BOLD: FACTORY STANDARD

# DIMENSIONS

Dimensions are in millimetres (inches).

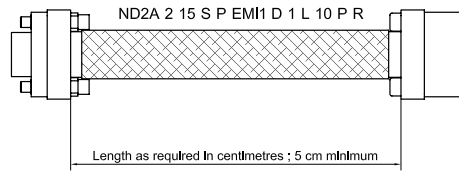

1 centimetre = 10 millimetres = 0,393 inch

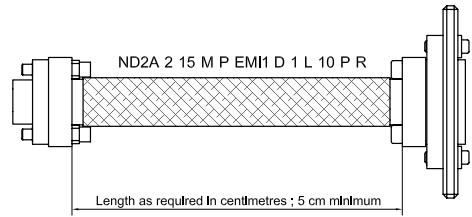

1 inch = 25,4 millimetres = 2,54 centimetres

## PANEL MOUNT RECEPTACLE

## PLUG

## RECEPTACLE

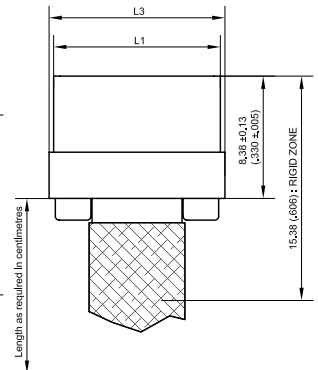
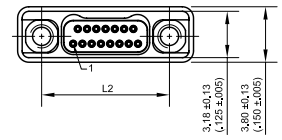
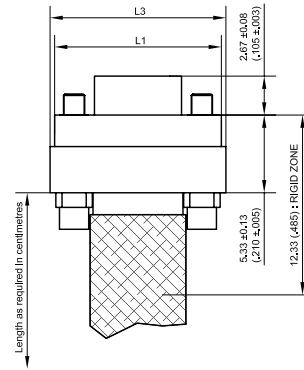
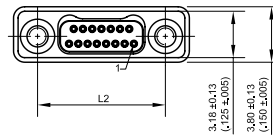
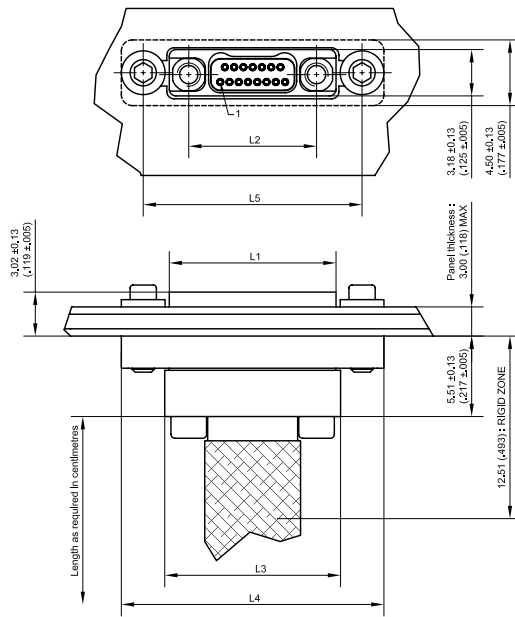

SHELL SIZE	L1 ±0.13 (±.005)	L2 ±0.13 (±.005)	L3 ±0.13 (±.005)	L4 ±0.13 (±.005)	L5 ±0.13 (±.005)
9 P / 9 S	9.53 .375	6.86 .270	10.16 .400	16.10 .634	13.10 .516
15 P / 15 S	11.43 .450	8.76 .345	12.06 .475	18.00 .709	15.00 .591
21 P / 21 S	13.34 .525	10.67 .420	13.97 .550	19.91 .784	16.91 .666
25 P / 25 S	14.61 .575	11.94 .470	15.24 .600	21.18 .834	18.18 .716
31 P / 31 S	16.51 .650	13.84 .545	17.14 .675	23.09 .909	20.08 .791
37 P / 37 S	18.42 .725	15.75 .620	19.05 .750	24.99 .984	21.99 .866
51 P / 51 S	22.86 .900	20.19 .795	23.49 .925	29.43 1.159	26.43 1.041

## SUMMARY OF CHARACTERISTICS

ELECTRICAL & MECHANICAL PERFORMANCE		MATERIAL & FINISH	
CURRENT RATING	1 A max.	SHELL	Aluminium alloy 6061 or 300 series stainless steel or titanium alloy, see page 209 for finish
CONTACT RESISTANCE	71 mΩ max.	BACKSHELL	Aluminium alloy 6061 with nickel plating
INSULATION RESISTANCE	5000 MΩ min. @ 100 Vdc	MOULDED INSULATOR	Liquid Crystal Polymer (LCP)
DIELECTRIC WITHSTANDING VOLTAGE	Sea level: 250 Vac	PIN CONTACT	Precious gold alloy
	Altitude 21 km (70,000 ft): 100 Vac	SOCKET CONTACT	Precious gold alloy
CONTACT ENGAGING FORCE	141 g max. (5 oz)	ENCAPSULANT	Epoxy resin
CONTACT SEPARATING FORCE	11 g min. (0.4 oz)	HARDWARE	300 series stainless steel, passivated
CONTACT RETENTION	0.9 kg (2 lbs)		
DURABILITY	200 mating cycles min.		
VIBRATION	20g's - No discontinuity > 1 μs		
SHOCK	100g's - No discontinuity > 1 μs		



PCB RECTANGULAR CONNECTORS

# BS TYPE DUAL ROW VERTICAL PCB RECEPTACLE

0.050" PITCH

- Reliability for micro-miniature operating systems.
- Several tail lengths available.
- Operating temperature: 150°C or 200°C.
- 7 contact arrangements (9 to 51 contacts).

Nano-D  
connectors

## IDENTIFICATION CODE



**SERIES**

ND2A: Nano-D 2-row AXON'.

**CONNECTOR TYPE**

**2:** Aluminium with electroless nickel plating and epoxy 150°C.  
**3:** Aluminium with electroless nickel plating and epoxy 200°C.  
 Other materials available on request (eg Titanium, Stainless Steel).

**NUMBER OF CONTACTS**

**09, 15, 21, 25, 31, 37, 51.**  
 Other versions available on request.

**CONNECTOR TYPE**

**S:** Receptacle connector.

**FAMILY**

**BS:** AXON' Vertical PCB connector.

**HARDWARE**

**P:** Threaded hole #0-80 UNF (non removable jackposts).  
 Other versions available on request.

**TAIL PLATING**

**G:** Gold.  
 Other tail plating available on request.

**TAIL LENGTH**

**1:** 2.77 mm (0.109").  
**2:** 3.56 mm (0.140").  
**3:** 4.37 mm (0.172").  
**4:** 2.29 mm (0.090").  
 Tolerance: ± 0.25 mm (0.010").

Connectors are supplied with #0-80 UNF screws 1/4" long (for PCB mounting).

IN BOLD: FACTORY STANDARD

# DIMENSIONS

Dimensions are in millimetres (inches).

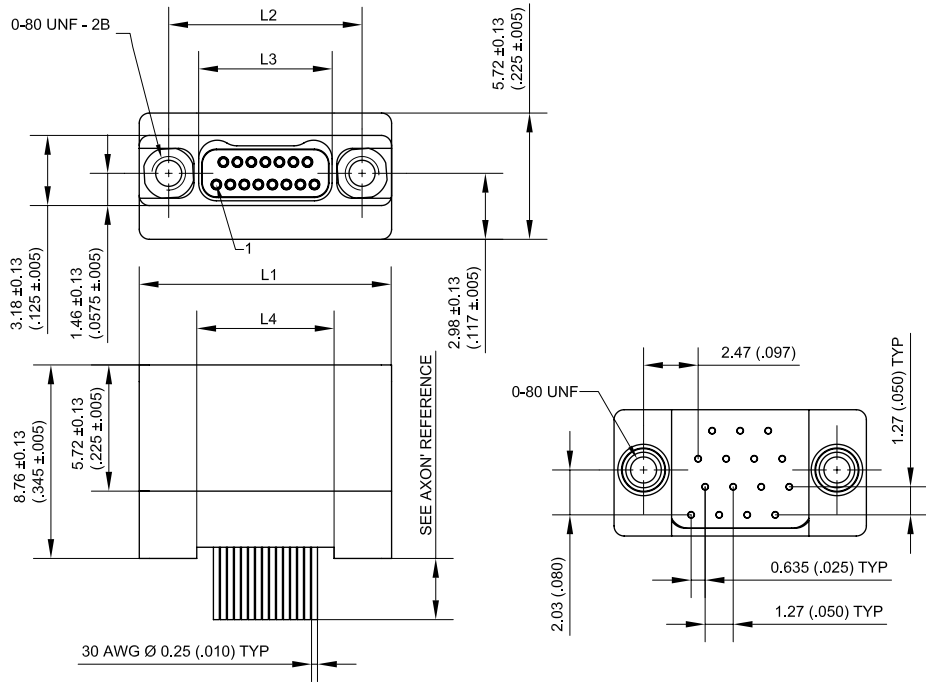

SEE CONTACT LAYOUT ON PCB PAGES 240

SHELL SIZE	L1 ±0.13 (±.005)	L2 ±0.13 (±.005)	L3 ±0.13 (±.005)	L4 ±0.13 (±.005)
9 S	9.53 .375	6.86 .270	4.14 .163	4.32 .170
15 S	11.43 .450	8.76 .345	6.05 .238	6.22 .245
21 S	13.34 .525	10.67 .420	7.95 .313	8.13 .320
25 S	14.61 .575	11.94 .470	9.22 .363	9.40 .370
31 S	16.51 .650	13.84 .545	11.12 .438	11.30 .445
37 S	18.42 .725	15.75 .620	13.03 .513	13.21 .520
51 S	22.86 .900	20.19 .795	17.48 .688	17.65 .695

## SUMMARY OF CHARACTERISTICS

ELECTRICAL & MECHANICAL PERFORMANCE		MATERIAL & FINISH	
CURRENT RATING	1 A max.	SHELL	Aluminium alloy 6061 or 300 series stainless steel or titanium alloy, see ordering for plating options
CONTACT RESISTANCE	71 mΩ max.	MOULDED INSULATOR	Liquid Crystal Polymer (LCP)
INSULATION RESISTANCE	5000 MΩ min. @ 100 Vdc	CONTACT	Copper alloy, gold over nickel plating
DIELECTRIC WITHSTANDING VOLTAGE	Sea level: 250 Vac Altitude 21 km (70,000 ft): 100 Vac	ENCAPSULANT	Epoxy Resin
CONTACT ENGAGING FORCE	141 g max. (5 oz)	PCB TERMINALS	Gold plated solid copper alloy wire
CONTACT SEPARATING FORCE	11 g min. (0.4 oz)	HARDWARE	300 series stainless steel, passivated
CONTACT RETENTION	0.9 kg (2 lbs)		
DURABILITY	200 mating cycles min.		
VIBRATION	20g's – No discontinuity > 1 μs		
SHOCK	100g's – No discontinuity > 1 μs		

SEE PAGE 209 FOR MORE INFORMATION

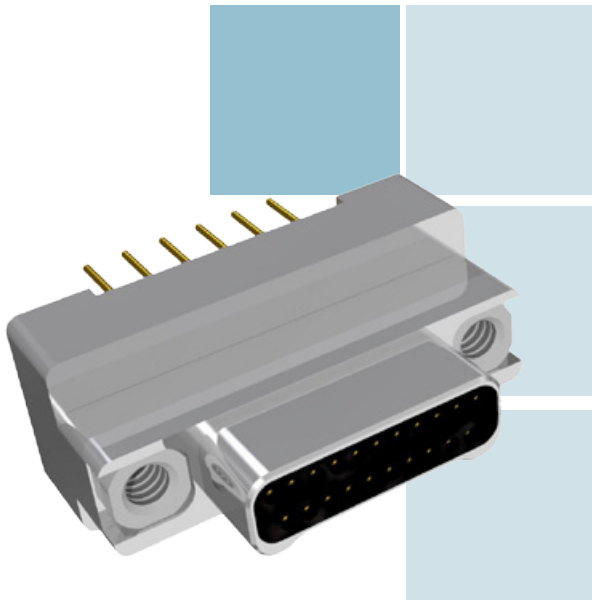

PCB RECTANGULAR CONNECTORS

**BS TYPE**  
**DUAL ROW VERTICAL**  
**PCB PLUG**

**0.050" PITCH**

- Reliability for micro-miniature operating systems.
- Several tail lengths available.
- Operating temperature: 150°C or 200°C.
- 7 contact arrangements (9 to 51 contacts).

IDENTIFICATION CODE

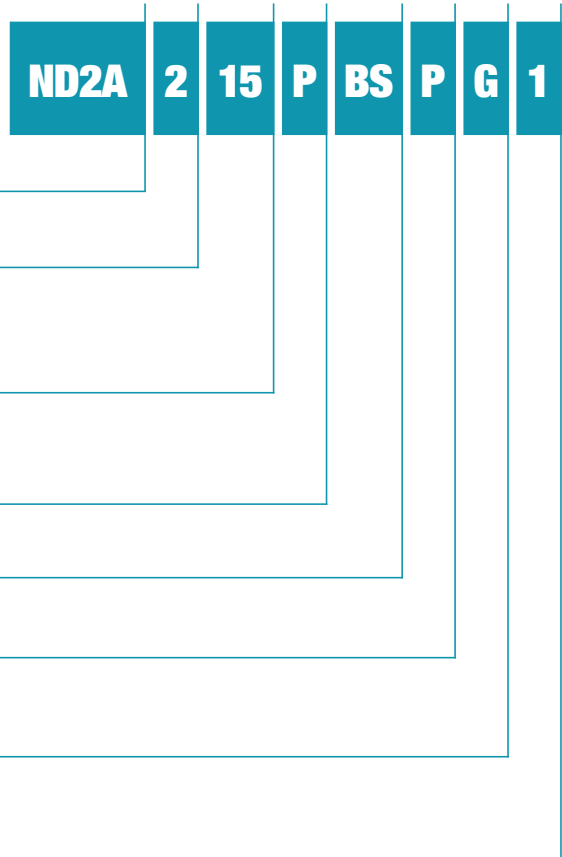

**SERIES**

**ND2A:** Nano-D 2-row AXON'.

**CONNECTOR TYPE**

**2:** Aluminium with electroless nickel plating and epoxy 150°C.  
**3:** Aluminium with electroless nickel plating and epoxy 200°C.  
Other materials available on request (eg Titanium, Stainless Steel).

**NUMBER OF CONTACTS**

**09, 15, 21, 25, 31, 37, 51.**  
Other versions available on request.

**CONNECTOR TYPE**

**P:** Plug connector.

**FAMILY**

**BS:** AXON' Vertical PCB connector.

**HARDWARE**

**P:** Threaded hole #0-80 UNF (non removable jackposts).  
Other versions available on request.

**TAIL PLATING**

**G:** Gold.  
Other tail plating available on request.

**TAIL LENGTH**

**1:** 2.77 mm (0.109").  
**2:** 3.56 mm (0.140").  
**3:** 4.37 mm (0.172").  
**4:** 2.29 mm (0.090").  
Tolerance: ± 0.25 mm (0.010").

Connectors are supplied with #0-80 UNF screws 1/4" long (for PCB mounting).

IN BOLD: FACTORY STANDARD



# DIMENSIONS

Dimensions are in millimetres (inches).

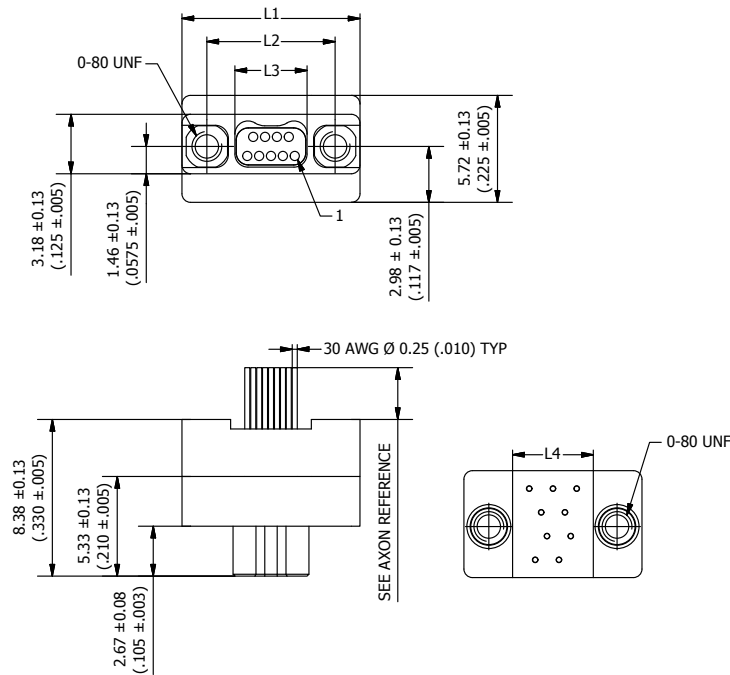

SEE CONTACT LAYOUT ON PCB PAGE 241

SHELL SIZE	L1 ±0.13 (±.005)	L2 ±0.13 (±.005)	L3 ±0.13 (±.005)	L4 ±0.13 (±.005)
9 P	9.53 .375	6.86 .270	4.06 .160	4.32 .170
15 P	11.43 .450	8.76 .345	5.97 .235	6.22 .245
21 P	13.34 .525	10.67 .420	7.87 .310	8.13 .320
25 P	14.61 .575	11.94 .470	9.14 .360	9.40 .370
31 P	16.51 .650	13.84 .545	11.05 .435	11.30 .445
37 P	18.42 .725	15.75 .620	12.95 .510	13.21 .520
51 P	22.86 .900	20.19 .795	17.40 .685	17.65 .695

## SUMMARY OF CHARACTERISTICS

ELECTRICAL & MECHANICAL PERFORMANCE		MATERIAL & FINISH	
CURRENT RATING	1 A max.	SHELL	Aluminium alloy 6061 or 300 series stainless steel or titanium alloy, see ordering for plating options
CONTACT RESISTANCE	71 mΩ max.	MOULDED INSULATOR	Liquid Crystal Polymer (LCP)
INSULATION RESISTANCE	5000 MΩ min. @ 100 Vdc	CONTACT	Precious gold alloy
DIELECTRIC WITHSTANDING VOLTAGE	Sea level: 250 Vac Altitude 21 km (70,000 ft): 100 Vac	ENCAPSULANT	Epoxy Resin
CONTACT ENGAGING FORCE	141 g max. (5 oz)	PCB TERMINALS	Gold plated solid copper alloy wire
CONTACT SEPARATING FORCE	11 g min. (0.4 oz)	HARDWARE	300 series stainless steel, passivated
CONTACT RETENTION	0.9 kg (2 lbs)		
DURABILITY	200 mating cycles min.		
VIBRATION	20g's – No discontinuity > 1 μs		
SHOCK	100g's – No discontinuity > 1 μs		

SEE PAGE 209 FOR MORE INFORMATION

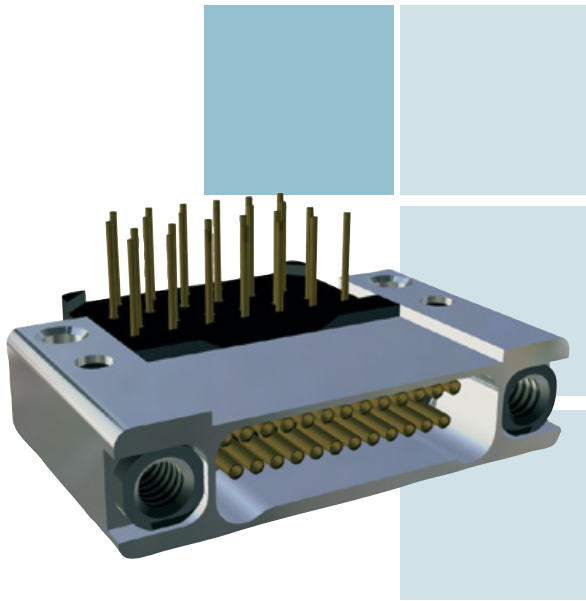

PCB RECTANGULAR CONNECTORS

# CBR TYPE DUAL ROW RIGHT ANGLE PCB RECEPTACLE

0.050" PITCH

- Reliability for micro-miniature operating systems.
- Several tail lengths available.
- Operating temperature: 150°C or 200°C.
- 7 contact arrangements (9 to 51 contacts).

## IDENTIFICATION CODE



**SERIES**

**ND2A:** Nano-D 2-row AXON'.

**CONNECTOR TYPE**

**2:** Aluminium with electroless nickel plating and epoxy 150°C.  
**3:** Aluminium with electroless nickel plating and epoxy 200°C.  
 Other materials available on request (eg Titanium, Stainless Steel).

**NUMBER OF CONTACTS**

**09, 15, 21, 25, 31, 37, 51.**  
 Other versions available on request.

**CONNECTOR TYPE**

**S:** Receptacle connector.

**FAMILY**

**CBR:** AXON' Right Angle PCB connector.

**HARDWARE**

**P:** Threaded hole #0-80 UNF (non removable jackposts).  
**B:** None.  
 Other versions available on request.

**TAIL PLATING**

**G:** Gold.  
 Other tail plating available on request.

**TAIL LENGTH**

**1: 2.77 mm (0.109").**  
**2: 3.56 mm (0.140").**  
**3: 4.37 mm (0.172").**  
**4: 2.29 mm (0.090").**  
 Tolerance: ± 0.25 mm (0.010").

Connectors are supplied with #0-80 UNF screws 1/4" long (for PCB mounting).

IN BOLD: FACTORY STANDARD

# DIMENSIONS

Dimensions are in millimetres (inches).

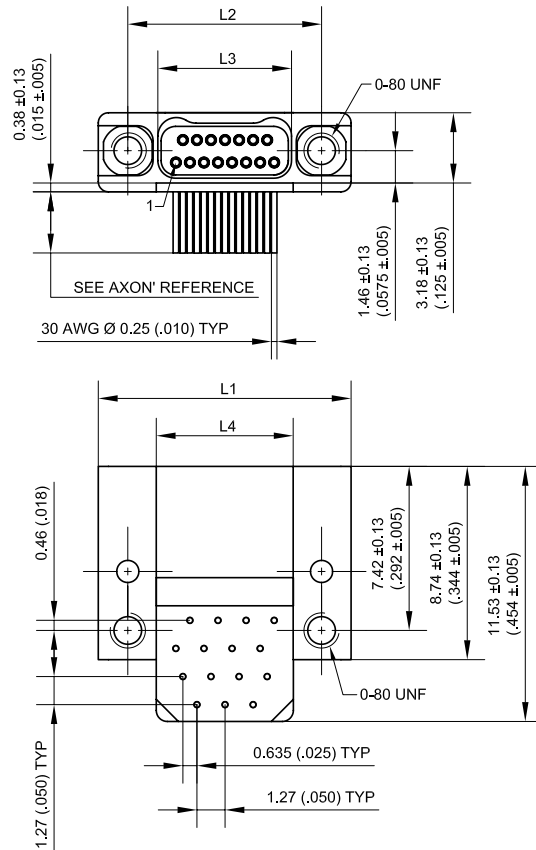

SEE CONTACT LAYOUT ON PCB PAGE 242

SHELL SIZE	L1 ±0.13 (±.005)	L2 ±0.13 (±.005)	L3 ±0.13 (±.005)	L4 ±0.13 (±.005)
9 S	9.53 .375	6.86 .270	4.14 .163	4.32 .170
15 S	11.43 .450	8.76 .345	6.05 .238	6.22 .245
21 S	13.34 .525	10.67 .420	7.95 .313	8.13 .320
25 S	14.61 .575	11.94 .470	9.22 .363	9.40 .370
31 S	16.51 .650	13.84 .545	11.12 .438	11.30 .445
37 S	18.42 .725	15.75 .620	13.03 .513	13.21 .520
51 S	22.86 .900	20.19 .795	17.48 .688	17.65 .695

## SUMMARY OF CHARACTERISTICS

ELECTRICAL & MECHANICAL PERFORMANCE		MATERIAL & FINISH	
CURRENT RATING	1 A max.	SHELL	Aluminium alloy 6061 or 300 series stainless steel or titanium alloy, see ordering for plating options
CONTACT RESISTANCE	71 mΩ max.	MOULDED INSULATOR	Liquid Crystal Polymer (LCP)
INSULATION RESISTANCE	5000 MΩ min. @ 100 Vdc	CONTACT	Copper alloy, gold over nickel plating
DIELECTRIC WITHSTANDING VOLTAGE	Sea level: 250 Vac Altitude 21 km (70,000 ft): 100 Vac	ENCAPSULANT	Epoxy Resin
CONTACT ENGAGING FORCE	141 g max. (5 oz)	PCB TERMINALS	Gold plated solid copper alloy wire
CONTACT SEPARATING FORCE	11 g min. (0.4 oz)	HARDWARE	300 series stainless steel, passivated
CONTACT RETENTION	0.9 kg (2 lbs)		
DURABILITY	200 mating cycles min.		
VIBRATION	20g's – No discontinuity > 1 μs		
SHOCK	100g's – No discontinuity > 1 μs		

SEE PAGE 209 FOR MORE INFORMATION

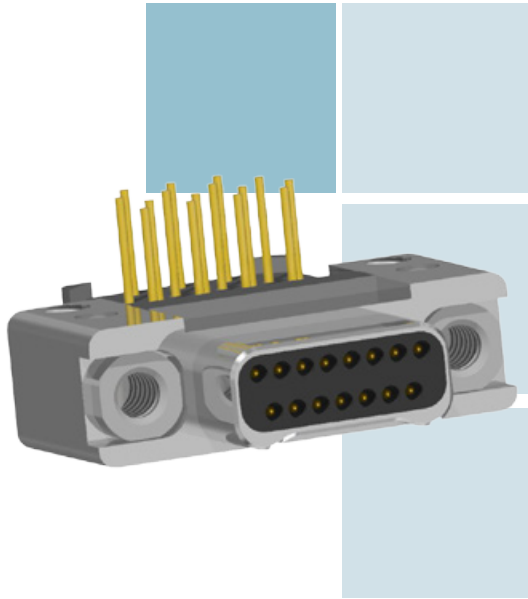

PCB RECTANGULAR CONNECTORS

# CBR TYPE

## DUAL ROW RIGHT ANGLE PCB PLUG

### 0.050" PITCH

- Reliability for micro-miniature operating systems.
- Several tail lengths available.
- Operating temperature: 150°C or 200°C.
- 7 contact arrangements (9 to 51 contacts).

### IDENTIFICATION CODE



**SERIES**

**ND2A:** Nano-D 2-row AXON'.

**CONNECTOR TYPE**

**2:** Aluminium with electroless nickel plating and epoxy 150°C.  
**3:** Aluminium with electroless nickel plating and epoxy 200°C.  
 Other materials available on request (eg Titanium, Stainless Steel).

**NUMBER OF CONTACTS**

**09, 15, 21, 25, 31, 37, 51.**  
 Other versions available on request.

**CONNECTOR TYPE**

**P:** Plug connector.

**FAMILY**

**CBR:** AXON' Right Angle PCB connector.

**HARDWARE**

**P:** Threaded hole #0-80 UNF (non removable jackposts).  
**B:** None.  
 Other versions available on request.

**TAIL PLATING**

**G:** Gold.  
 Other tail plating available on request.

**TAIL LENGTH**

**1:** 2.77 mm (0.109").  
**2:** 3.56 mm (0.140").  
**3:** 4.37 mm (0.172").  
**4:** 2.29 mm (0.090").  
 Tolerance: ± 0.25 mm (0.010").

Connectors are supplied with #0-80 UNF screws 1/4" long (for PCB mounting).

IN BOLD: FACTORY STANDARD

# DIMENSIONS

Dimensions are in millimetres (inches).

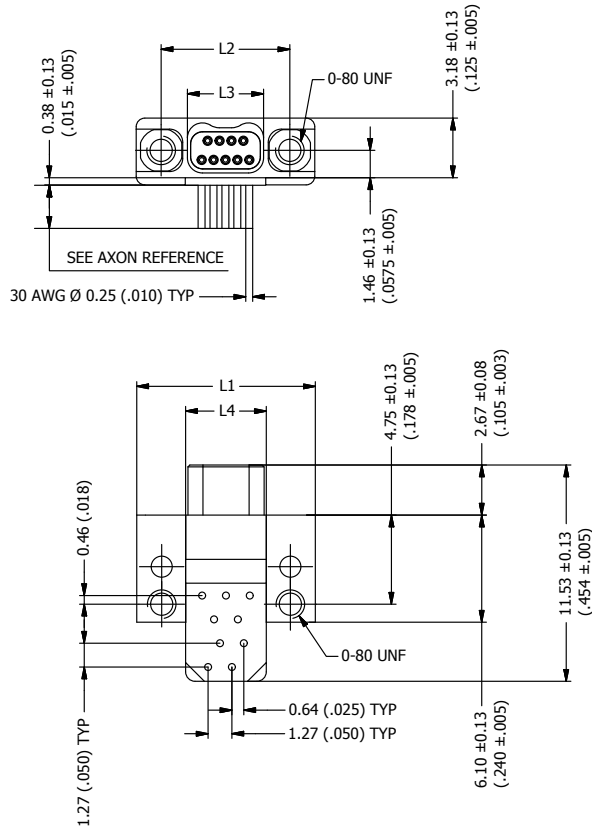

SEE CONTACT LAYOUT ON PCB PAGE 243

SHELL SIZE	L1 ±0.13 (±.005)	L2 ±0.13 (±.005)	L3 ±0.13 (±.005)	L4 ±0.13 (±.005)
9 P	9.53 .375	6.86 .270	4.06 .160	4.32 .170
15 P	11.43 .450	8.76 .345	5.97 .235	6.22 .245
21 P	13.34 .525	10.67 .420	7.87 .310	8.13 .320
25 P	14.61 .575	11.94 .470	9.14 .360	9.40 .370
31 P	16.51 .650	13.84 .545	11.05 .435	11.30 .445
37 P	18.42 .725	15.75 .620	12.95 .510	13.21 .520
51 P	22.86 .900	20.19 .795	17.40 .685	17.65 .695

## SUMMARY OF CHARACTERISTICS

ELECTRICAL & MECHANICAL PERFORMANCE		MATERIAL & FINISH	
CURRENT RATING	1 A max.	SHELL	Aluminium alloy 6061 or 300 series stainless steel or titanium alloy, see ordering for plating options
CONTACT RESISTANCE	71 mΩ max.	MOULDED INSULATOR	Liquid Crystal Polymer (LCP)
INSULATION RESISTANCE	5000 MΩ min. @ 100 Vdc	CONTACT	Precious gold alloy
DIELECTRIC WITHSTANDING VOLTAGE	Sea level: 250 VAc Altitude 21 km (70,000 ft): 100 VAc	ENCAPSULANT	Epoxy Resin
CONTACT ENGAGING FORCE	141 g max. (5 oz)	PCB TERMINALS	Gold plated solid copper alloy wire
CONTACT SEPARATING FORCE	11 g min. (0.4 oz)	HARDWARE	300 series stainless steel, passivated
CONTACT RETENTION	0.9 kg (2 lbs)		
DURABILITY	200 mating cycles min.		
VIBRATION	20g's – No discontinuity > 1 μs		
SHOCK	100g's – No discontinuity > 1 μs		

SEE PAGE 209 FOR MORE INFORMATION

# SMV TYPE

## DUAL ROW VERTICAL SURFACE MOUNT PCB RECEPTACLE

0.025" PITCH

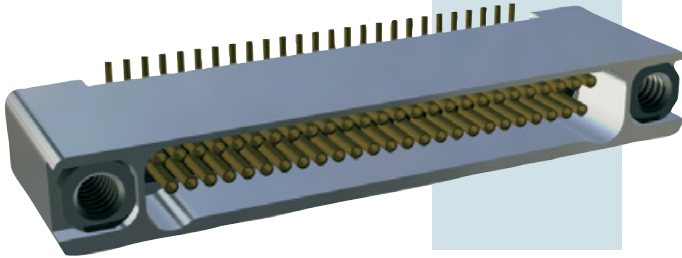

- Reliability for micro-miniature operating systems.
- Surface Mount.
- Several tail lengths available.
- Operating temperature: 150°C or 200°C.
- 7 contact arrangements (9 to 51 contacts).

### IDENTIFICATION CODE

**ND2A**

**2**

**15**

**S**

**SMV**

**P**

**G**

**1**

#### SERIES

**ND2A:** Nano-D 2-row AXON'.

#### CONNECTOR TYPE

**2:** Aluminium with electroless nickel plating and epoxy 150°C.

**3:** Aluminium with electroless nickel plating and epoxy 200°C.

Other materials available on request (eg Titanium, Stainless Steel).

#### NUMBER OF CONTACTS

**09, 15, 21, 25, 31, 37, 51.**

Other versions available on request.

#### CONNECTOR TYPE

**S:** Receptacle connector.

#### FAMILY

**SMV:** AXON' Vertical surface mount PCB connector.

#### HARDWARE

**P:** Threaded holes #0-80 UNF (non removable jackposts).

Other versions available on request.

**B:** None.

#### TAIL PLATING

**G:** Gold, AWG 30.

Other tail plating available on request.

#### TAIL LENGTH

**1:** 0.51 mm (0.020").

**2:** 1.02 mm (0.040").

Tolerance: ± 0.25 mm (0.010").

Connectors are supplied with #0-80 UNF screws 1/4" long (for PCB mounting).

IN BOLD: FACTORY STANDARD

# DIMENSIONS

Dimensions are in millimetres (inches).

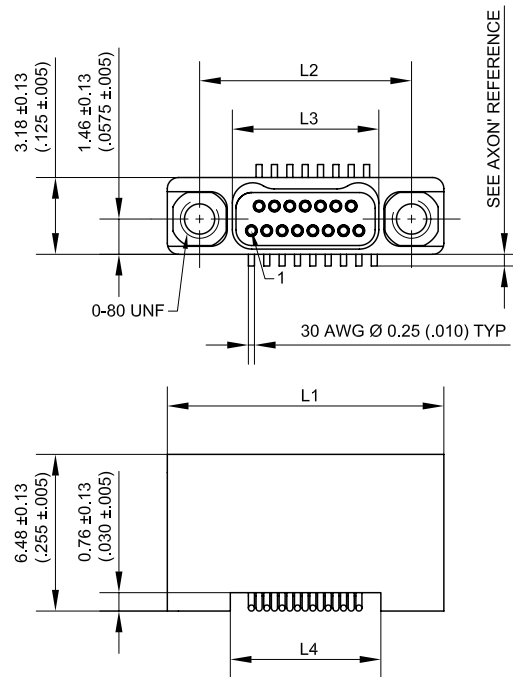

SEE CONTACT LAYOUT ON PCB PAGES 244 & 245

SHELL SIZE	L1 ±0.13 (±.005)	L2 ±0.13 (±.005)	L3 ±0.13 (±.005)	L4 ±0.13 (±.005)
9 S	9.53 .375	6.86 .270	4.14 .163	4.32 .170
15 S	11.43 .450	8.76 .345	6.05 .238	6.22 .245
21 S	13.34 .525	10.67 .420	7.95 .313	8.13 .320
25 S	14.61 .575	11.94 .470	9.22 .363	9.40 .370
31 S	16.51 .650	13.84 .545	11.12 .438	11.30 .445
37 S	18.42 .725	15.75 .620	13.03 .513	13.21 .520
51 S	22.86 .900	20.19 .795	17.48 .688	17.65 .695

## SUMMARY OF CHARACTERISTICS

ELECTRICAL & MECHANICAL PERFORMANCE	
CURRENT RATING	1 A max.
CONTACT RESISTANCE	71 mΩ max.
INSULATION RESISTANCE	5000 MΩ min. @ 100 Vdc
DIELECTRIC WITHSTANDING VOLTAGE	Sea level: 250 VAc Altitude 21 km (70,000 ft): 100 VAc
CONTACT ENGAGING FORCE	141 g max. (5 oz)
CONTACT SEPARATING FORCE	11 g min. (0.4 oz)
CONTACT RETENTION	0.9 kg (2 lbs)
DURABILITY	200 mating cycles min.
VIBRATION	20g's - No discontinuity > 1 μs
SHOCK	100g's - No discontinuity > 1 μs

MATERIAL & FINISH	
SHELL	Aluminium alloy 6061 or 300 series stainless steel or titanium alloy, see ordering for plating options
MOULDED INSULATOR	Liquid Crystal Polymer (LCP)
CONTACT	Copper alloy, gold over nickel plating
ENCAPSULANT	Epoxy Resin
PCB TERMINALS	Gold plated solid copper alloy wire
HARDWARE	300 series stainless steel, passivated

SEE PAGE 209 FOR MORE INFORMATION

PCB RECTANGULAR CONNECTORS

# SMV TYPE

## DUAL ROW VERTICAL SURFACE MOUNT PCB PLUG

0.025" PITCH

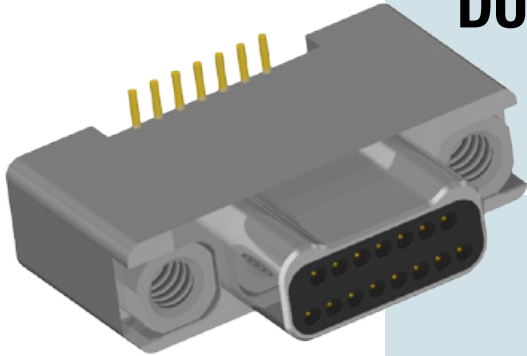

- Reliability for micro-miniature operating systems.
- Surface Mount.
- Several tail lengths available.
- Operating temperature: 150°C or 200°C.
- 7 contact arrangements (9 to 51 contacts).

### IDENTIFICATION CODE

ND2A	2	15	P	SMV	P	G	1
------	---	----	---	-----	---	---	---

**SERIES**

**ND2A:** Nano-D 2-row AXON'.

**CONNECTOR TYPE**

- 2:** Aluminium with electroless nickel plating and epoxy 150°C.
- 3:** Aluminium with electroless nickel plating and epoxy 200°C.
- Other materials available on request (eg Titanium, Stainless Steel).**

**NUMBER OF CONTACTS**

**09, 15, 21, 25, 31, 37, 51.**  
Other versions available on request.

**CONNECTOR TYPE**

**P:** Plug connector.

**FAMILY**

**SMV:** AXON' Vertical surface mount PCB connector.

**HARDWARE**

- P:** Threaded holes #0-80 UNF (non removable jackposts).
- Other versions available on request.**
- B:** None.

**TAIL PLATING**

**G:** Gold, AWG 30.  
Other tail plating available on request.

**TAIL LENGTH**

**1:** 0.51 mm (0.020").  
**2:** 1.02 mm (0.040").  
Tolerance: ± 0.25 mm (0.010").

Connectors are supplied with #0-80 UNF screws 1/4" long (for PCB mounting).

IN BOLD: FACTORY STANDARD



# DIMENSIONS

Dimensions are in millimetres (inches).

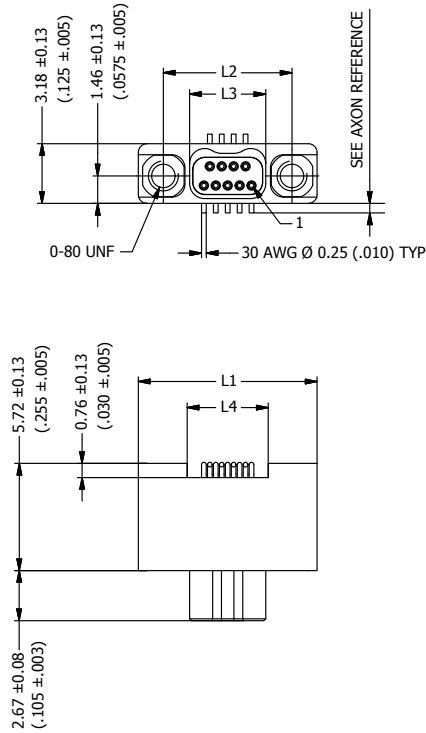

SEE CONTACT LAYOUT ON PCB PAGES 246 & 247

SHELL SIZE	L1 ±0.13 (±.005)	L2 ±0.13 (±.005)	L3 ±0.13 (±.005)	L4 ±0.13 (±.005)
9 P	9.53 .375	6.86 .270	4.06 .160	4.32 .170
15 P	11.43 .450	8.76 .345	5.97 .235	6.22 .245
21 P	13.34 .525	10.67 .420	7.87 .310	8.13 .320
25 P	14.61 .575	11.94 .470	9.14 .360	9.40 .370
31 P	16.51 .650	13.84 .545	11.05 .435	11.30 .445
37 P	18.42 .725	15.75 .620	12.95 .510	13.21 .520
51 P	22.86 .900	20.19 .795	17.40 .685	17.65 .695

## SUMMARY OF CHARACTERISTICS

ELECTRICAL & MECHANICAL PERFORMANCE		MATERIAL & FINISH	
CURRENT RATING	1 A max.	SHELL	Aluminium alloy 6061 or 300 series stainless steel or titanium alloy, see ordering for plating options
CONTACT RESISTANCE	71 mΩ max.	MOULDED INSULATOR	Liquid Crystal Polymer (LCP)
INSULATION RESISTANCE	5000 MΩ min. @ 100 Vdc	CONTACT	Precious gold alloy
DIELECTRIC WITHSTANDING VOLTAGE	Sea level: 250 Vac Altitude 21 km (70,000 ft): 100 Vac	ENCAPSULANT	Epoxy Resin
CONTACT ENGAGING FORCE	141 g max. (5 oz)	PCB TERMINALS	Gold plated solid copper alloy wire
CONTACT SEPARATING FORCE	11 g min. (0.4 oz)	HARDWARE	300 series stainless steel, passivated
CONTACT RETENTION	0.9 kg (2 lbs)		
DURABILITY	200 mating cycles min.		
VIBRATION	20g's – No discontinuity > 1 μs		
SHOCK	100g's – No discontinuity > 1 μs		

SEE PAGE 209 FOR MORE INFORMATION

PCB RECTANGULAR CONNECTORS

# SMH TYPE

## DUAL ROW HORIZONTAL SURFACE MOUNT PCB RECEPTACLE

0.025" PITCH

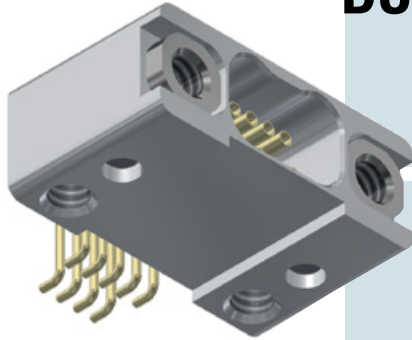

- Reliability for micro-miniature operating systems.
- Surface Mount.
- Operating temperature: 150°C or 200°C.
- 7 contact arrangements (9 to 51 contacts).

### IDENTIFICATION CODE

ND2A	2	15	S	SMH	P	G	1
------	---	----	---	-----	---	---	---

**SERIES**

**ND2A:** Nano-D 2-row AXON'.

**CONNECTOR TYPE**

**2:** Aluminium with electroless nickel plating and epoxy 150°C.  
**3:** Aluminium with electroless nickel plating and epoxy 200°C.  
 Other materials available on request (eg Titanium, Stainless Steel).

**NUMBER OF CONTACTS**

**09, 15, 21, 25, 31, 37, 51.**  
 Other versions available on request.

**CONNECTOR TYPE**

**S:** Receptacle connector.

**FAMILY**

**SMH:** AXON' Horizontal surface mount PCB connector.

**HARDWARE**

**P:** Threaded holes #0-80 UNF (non removable jackposts).  
 Other versions available on request.  
**B:** None.

**TAIL PLATING**

**G:** Gold, AWG 30.  
 Other tail plating available on request.

**TAIL LENGTH**

**1:** Standard (see page 237 for dimensions).

Connectors are supplied with #0-80 UNF screws 1/4" long (for PCB mounting).

IN BOLD: FACTORY STANDARD

# DIMENSIONS

Dimensions are in millimetres (inches).

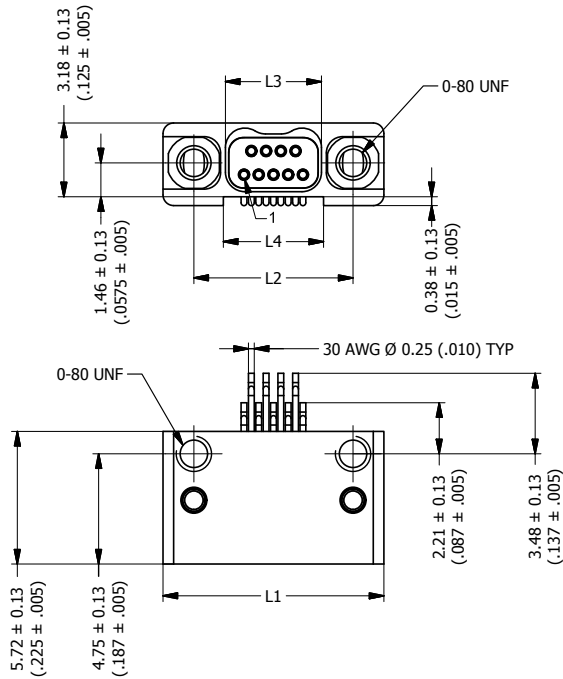

SEE CONTACT LAYOUT ON PCB PAGES 248 & 249

SHELL SIZE	L1 $\pm 0.13$ ( $\pm .005$ )	L2 $\pm 0.13$ ( $\pm .005$ )	L3 $\pm 0.13$ ( $\pm .005$ )	L4 $\pm 0.13$ ( $\pm .005$ )
9 S	9.53 .375	6.86 .270	4.14 .163	4.32 .170
15 S	11.43 .450	8.76 .345	6.05 .238	6.22 .245
21 S	13.34 .525	10.67 .420	7.95 .313	8.13 .320
25 S	14.61 .575	11.94 .470	9.22 .363	9.40 .370
31 S	16.51 .650	13.84 .545	11.12 .438	11.30 .445
37 S	18.42 .725	15.75 .620	13.03 .513	13.21 .520
51 S	22.86 .900	20.19 .795	17.48 .688	17.65 .695

## SUMMARY OF CHARACTERISTICS

ELECTRICAL & MECHANICAL PERFORMANCE		MATERIAL & FINISH	
CURRENT RATING	1 A max.	SHELL	Aluminium alloy 6061 or 300 series stainless steel or titanium alloy, see ordering for plating options
CONTACT RESISTANCE	71 m $\Omega$ max.	MOULDED INSULATOR	Liquid Crystal Polymer (LCP)
INSULATION RESISTANCE	5000 M $\Omega$ min. @ 100 Vdc	CONTACT	Precious gold alloy
DIELECTRIC WITHSTANDING VOLTAGE	Sea level: 250 Vac Altitude 21 km (70,000 ft): 100 Vac	ENCAPSULANT	Epoxy resin
CONTACT ENGAGING FORCE	141 g max. (5 oz)	PCB TERMINALS	Gold plated solid copper alloy wire
CONTACT SEPARATING FORCE	11 g min. (0.4 oz)	HARDWARE	300 series stainless steel, passivated
CONTACT RETENTION	0.9 kg (2 lbs)		
DURABILITY	200 mating cycles min.		
VIBRATION	20g's - No discontinuity > 1 $\mu$ s		
SHOCK	100g's - No discontinuity > 1 $\mu$ s		

SEE PAGE 209 FOR MORE INFORMATION

PCB RECTANGULAR CONNECTORS

# SMH TYPE

## DUAL ROW HORIZONTAL SURFACE MOUNT PCB PLUG

0.025" PITCH

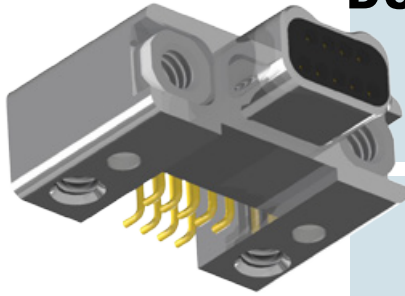

- Reliability for micro-miniature operating systems.
- Surface Mount.
- Operating temperature: 150°C or 200°C.
- 7 contact arrangements (9 to 51 contacts).

### IDENTIFICATION CODE

ND2A	2	15	P	SMH	P	G	1
------	---	----	---	-----	---	---	---

**SERIES**

**ND2A:** Nano-D 2-row AXON'.

**CONNECTOR TYPE**

- 2:** Aluminium with electroless nickel plating and epoxy 150°C.
  - 3:** Aluminium with electroless nickel plating and epoxy 200°C.
- Other materials available on request (eg Titanium, Stainless Steel).

**NUMBER OF CONTACTS**

**09, 15, 21, 25, 31, 37, 51.**  
Other versions available on request.

**CONNECTOR TYPE**

**P:** Plug connector.

**FAMILY**

**SMH:** AXON' Horizontal surface mount PCB connector.

**HARDWARE**

- P:** Threaded holes #0-80 UNF (non removable jackposts).
- Other versions available on request.  
**B:** None.

**TAIL PLATING**

**G:** Gold, AWG 30.  
Other tail plating available on request.

**TAIL LENGTH**

**1:** Standard (see page 239 for dimensions).

Connectors are supplied with #0-80 UNF screws 1/4" long (for PCB mounting).

IN BOLD: FACTORY STANDARD

# DIMENSIONS

Dimensions are in millimetres (inches).

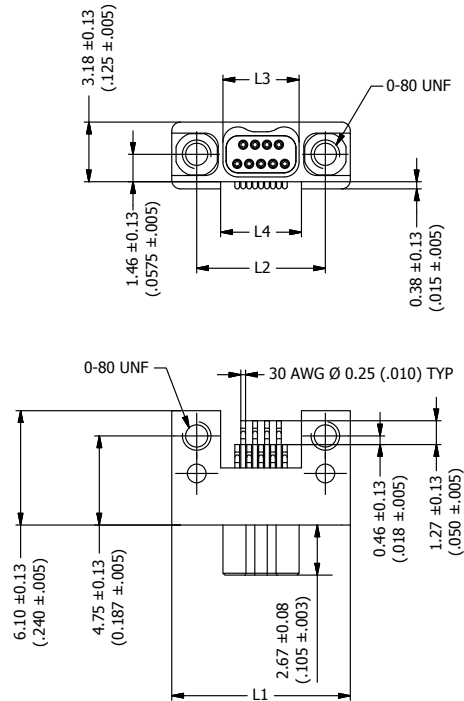

SEE CONTACT LAYOUT ON PCB PAGE 250 & 251

SHELL SIZE	L1 ±0.13 (±.005)	L2 ±0.13 (±.005)	L3 ±0.13 (±.005)	L4 ±0.13 (±.005)
9 P	9.53 .375	6.86 .270	4.06 .160	4.32 .170
15 P	11.43 .450	8.76 .345	5.97 .235	6.22 .245
21 P	13.34 .525	10.67 .420	7.87 .310	8.13 .320
25 P	14.61 .575	11.94 .470	9.14 .360	9.40 .370
31 P	16.51 .650	13.84 .545	11.05 .435	11.30 .445
37 P	18.42 .725	15.75 .620	12.95 .510	13.21 .520
51 P	22.86 .900	20.19 .795	17.40 .685	17.65 .695

## SUMMARY OF CHARACTERISTICS

ELECTRICAL & MECHANICAL PERFORMANCE		MATERIAL & FINISH	
CURRENT RATING	1 A max.	SHELL	Aluminium alloy 6061 or 300 series stainless steel or titanium alloy, see ordering for plating options
CONTACT RESISTANCE	71 mΩ max.	MOULDED INSULATOR	Liquid Crystal Polymer (LCP)
INSULATION RESISTANCE	5000 MΩ min. @ 100 Vdc	CONTACT	Precious gold alloy
DIELECTRIC WITHSTANDING VOLTAGE	Sea level: 250 Vac Altitude 21 km (70,000 ft): 100 Vac	ENCAPSULANT	Epoxy resin
CONTACT ENGAGING FORCE	141 g max. (5 oz)	PCB TERMINALS	Gold plated solid copper alloy wire
CONTACT SEPARATING FORCE	11 g min. (0.4 oz)	HARDWARE	300 series stainless steel, passivated
CONTACT RETENTION	0.9 kg (2 lbs)		
DURABILITY	200 mating cycles min.		
VIBRATION	20g's – No discontinuity > 1 μs		
SHOCK	100g's – No discontinuity > 1 μs		

SEE PAGE 209 FOR MORE INFORMATION

# PCB LAYOUT FOR BS TYPE 0.050" PITCH - FEMALE CONNECTORS

VIEW A

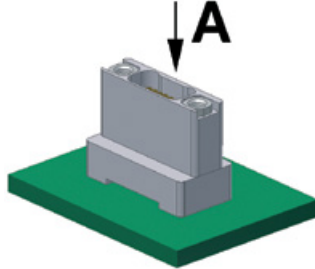

9 CONTACTS - VIEW A

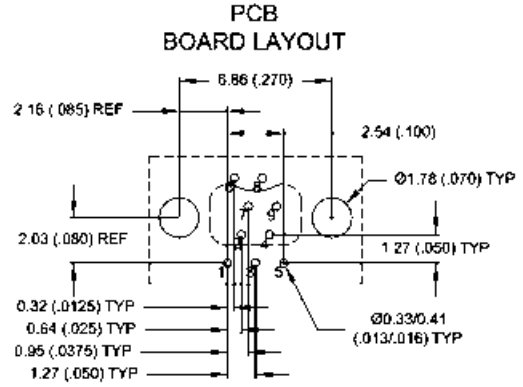

15 CONTACTS - VIEW A

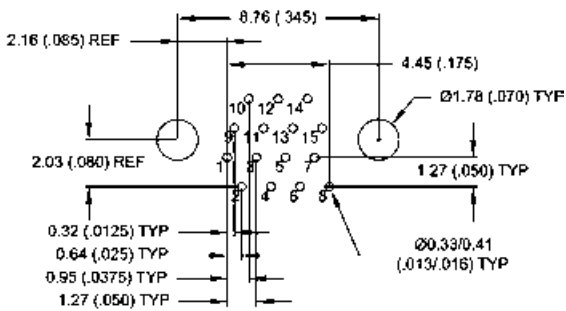

21 CONTACTS - VIEW A

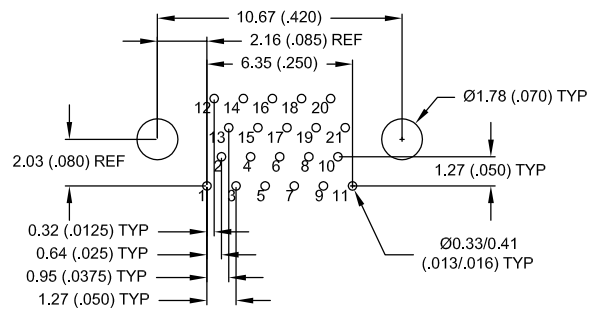

25 CONTACTS - VIEW A

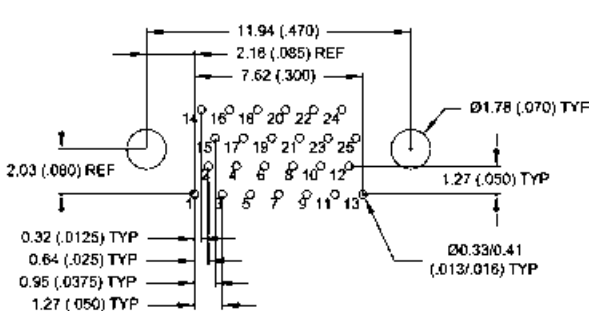

31 CONTACTS - VIEW A

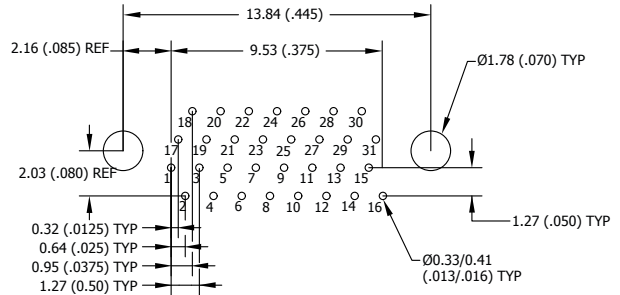

37 CONTACTS - VIEW A

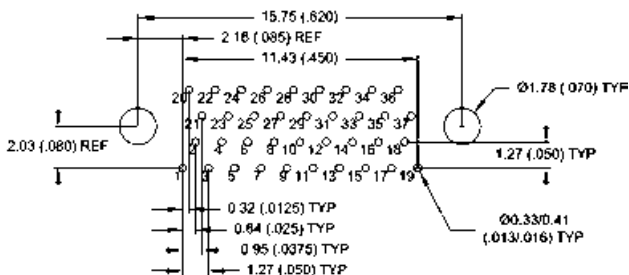

51 CONTACTS - VIEW A

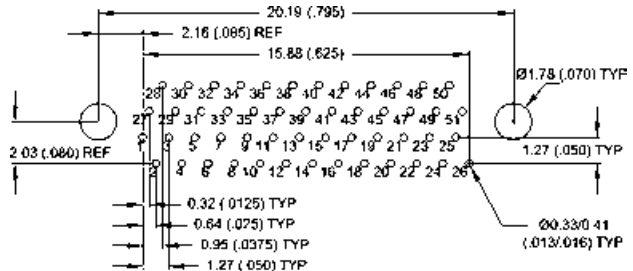

1.27 mm (0.05") contact spacing - 1.27 mm (0.05") spacing between rows - contact diameter: AWG 30

# PCB LAYOUT FOR BS TYPE 0.050" PITCH - MALE CONNECTORS

VIEW A

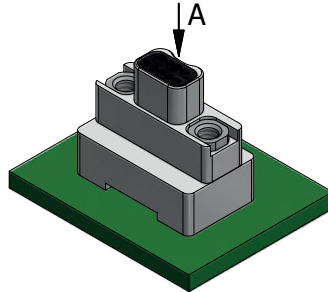

9 CONTACTS - VIEW A

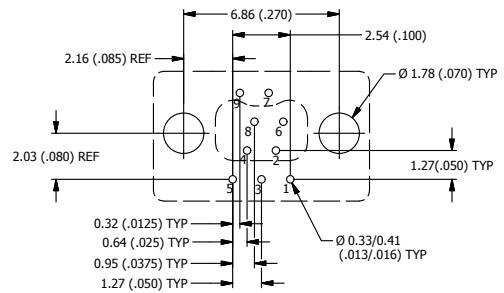

15 CONTACTS - VIEW A

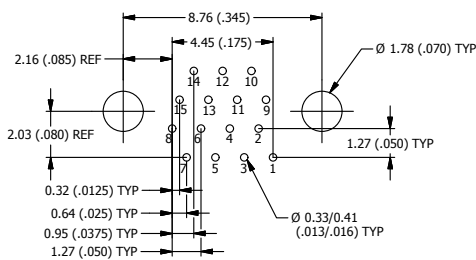

21 CONTACTS - VIEW A

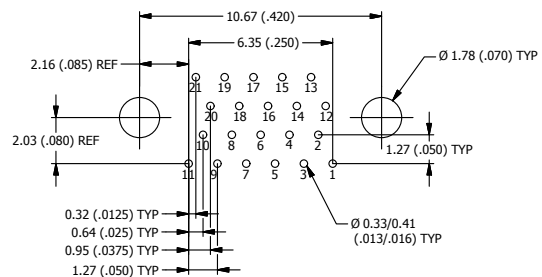

25 CONTACTS - VIEW A

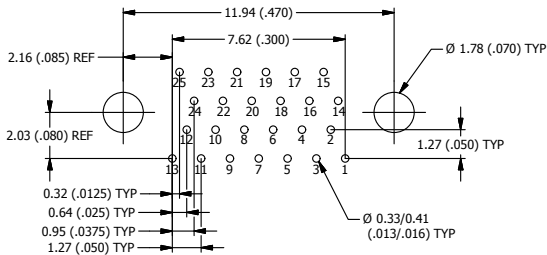

31 CONTACTS - VIEW A

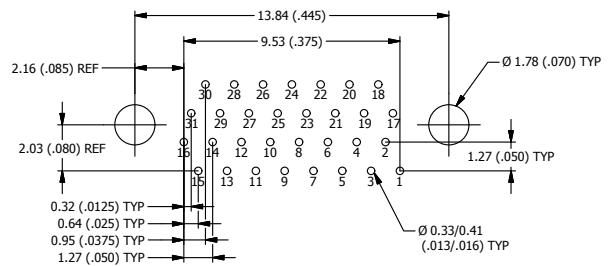

37 CONTACTS - VIEW A

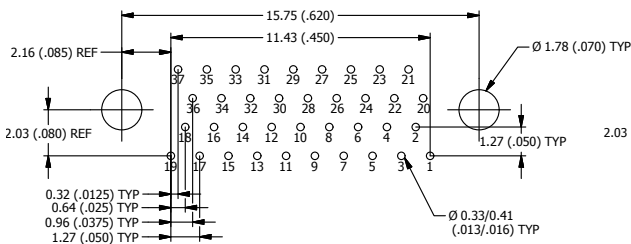

51 CONTACTS - VIEW A

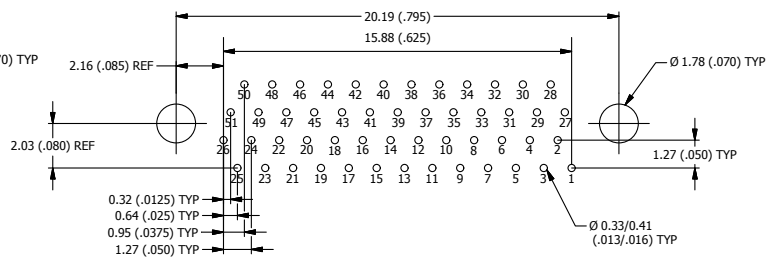

DUAL ROW  
NANO-D CONNECTORS

Nano-D  
connectors

# PCB LAYOUT FOR CBR TYPE 0.050" PITCH - FEMALE CONNECTORS

VIEW A

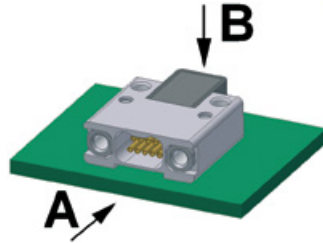

9 CONTACTS - VIEW B

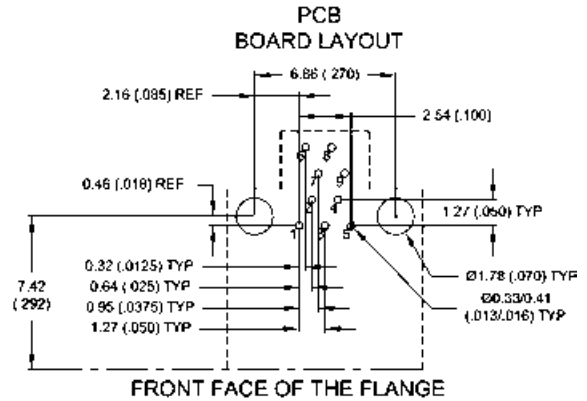

15 CONTACTS - VIEW B

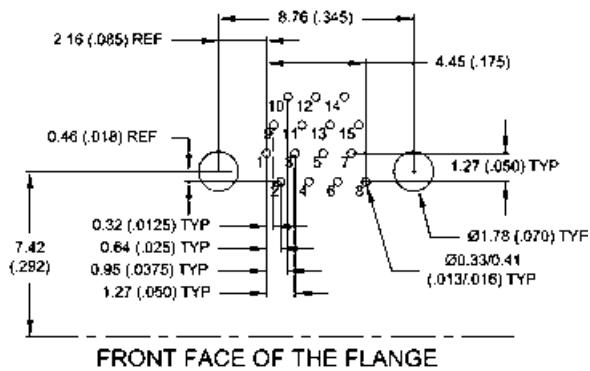

21 CONTACTS - VIEW B

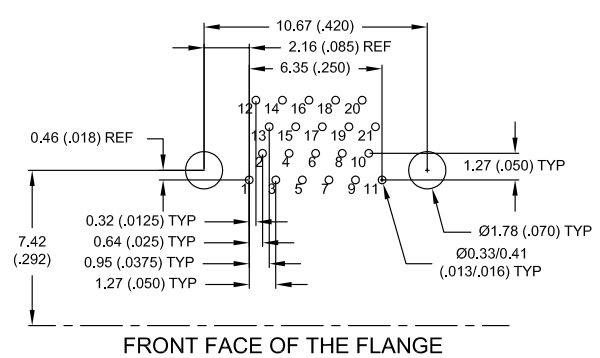

25 CONTACTS - VIEW B

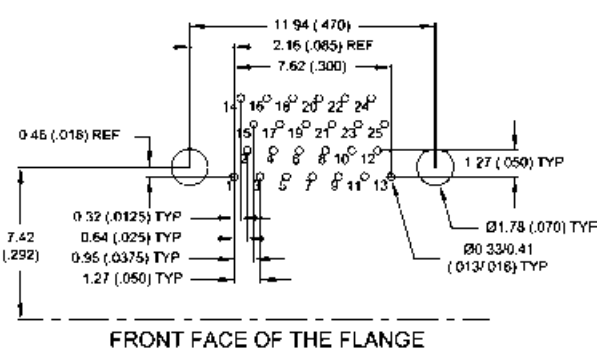

31 CONTACTS - VIEW B

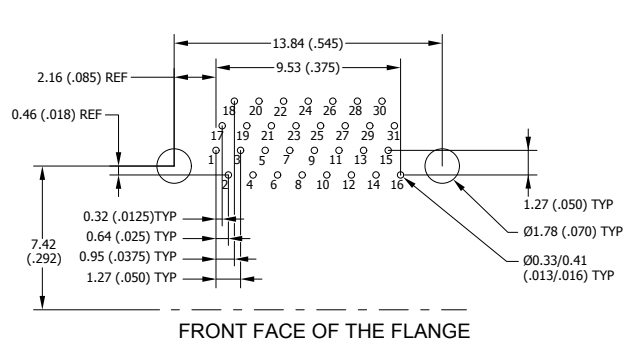

37 CONTACTS - VIEW B

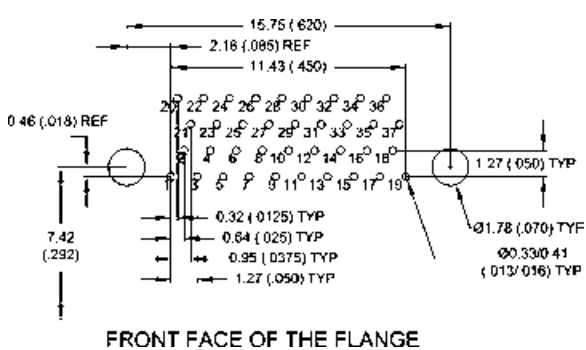

51 CONTACTS - VIEW B

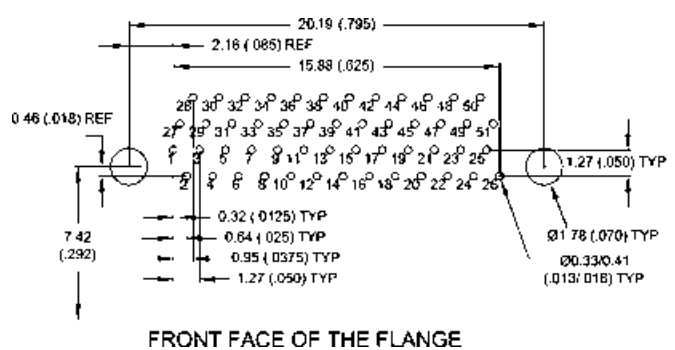

1.27 mm (0.05") contact spacing - 1.27 mm (0.05") spacing between rows - contact diameter: AWG 30



# PCB LAYOUT FOR CBR TYPE 0.050" PITCH - MALE CONNECTORS

VIEW A

CONNECTOR  
MATING FACE

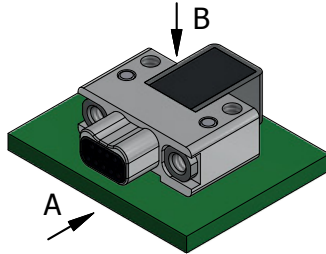
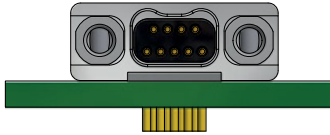

9 CONTACTS - VIEW B

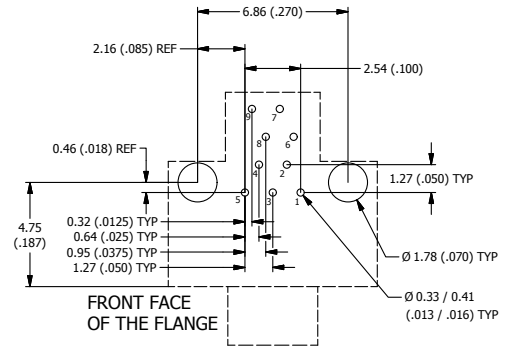

15 CONTACTS - VIEW B

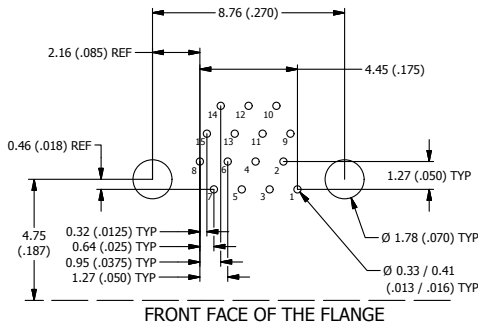

21 CONTACTS - VIEW B

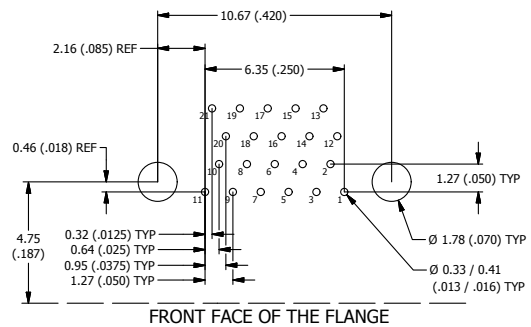

25 CONTACTS - VIEW B

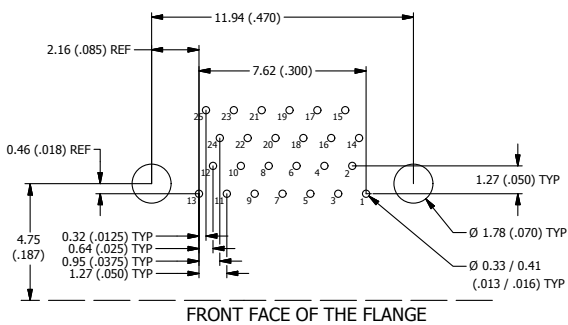

31 CONTACTS - VIEW B

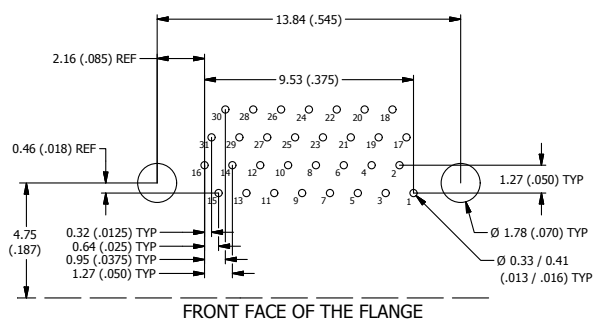

37 CONTACTS - VIEW B

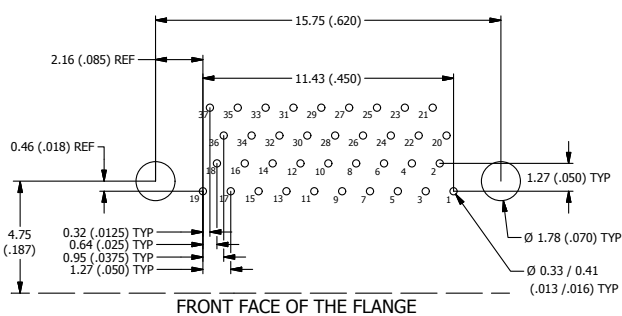

51 CONTACTS - VIEW B

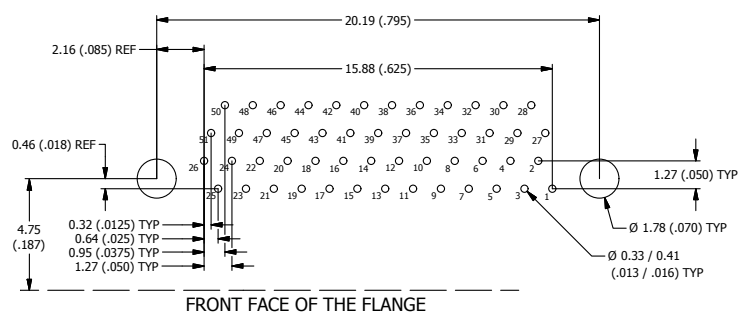

DUAL ROW  
NANO-D CONNECTORS

Nano-D  
connectors

# PCB LAYOUT FOR SMV TYPE 0.025" PITCH - FEMALE CONNECTORS

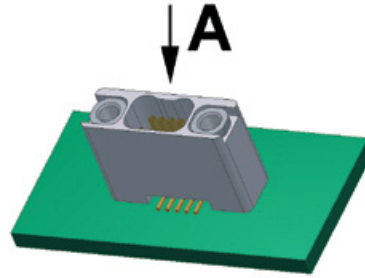
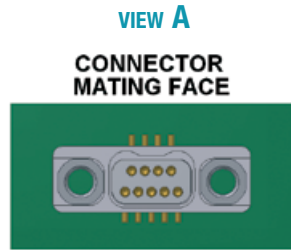

**9 CONTACTS - VIEW A**

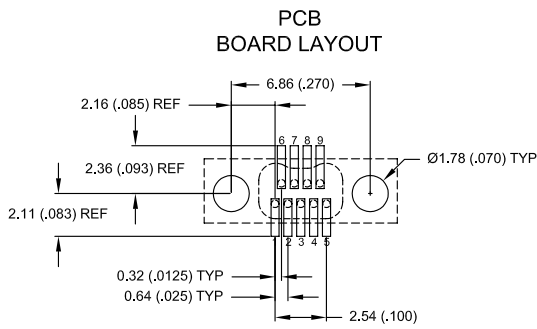

**15 CONTACTS - VIEW A**

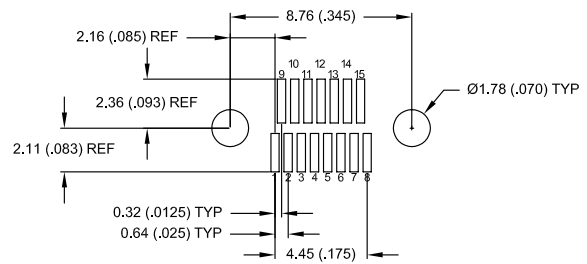

**21 CONTACTS - VIEW A**

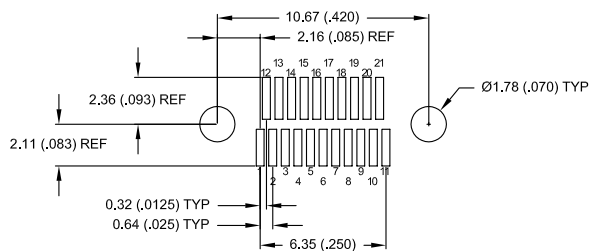

**25 CONTACTS - VIEW A**

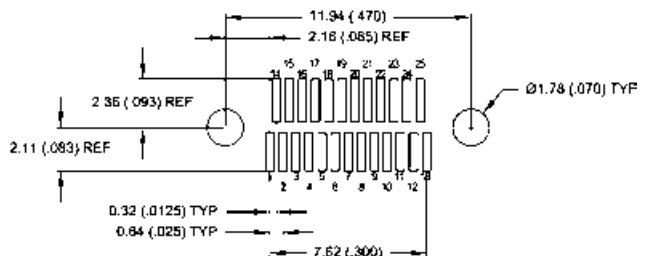

0.635 mm (0.025") pad - contact diameter: AWG 30

# PCB LAYOUT FOR SMV TYPE 0.025" PITCH - FEMALE CONNECTORS

### 31 CONTACTS - VIEW A

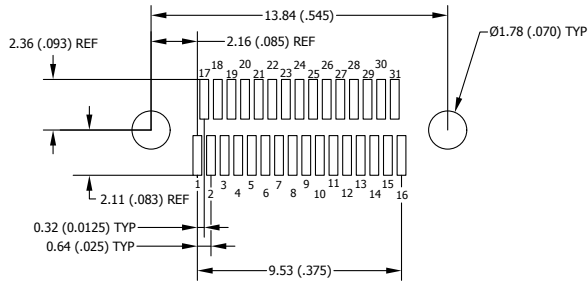

### 37 CONTACTS - VIEW A

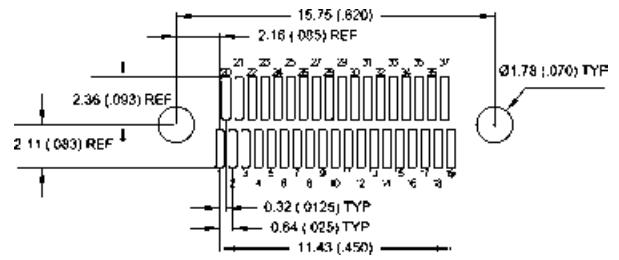

### 51 CONTACTS - VIEW A

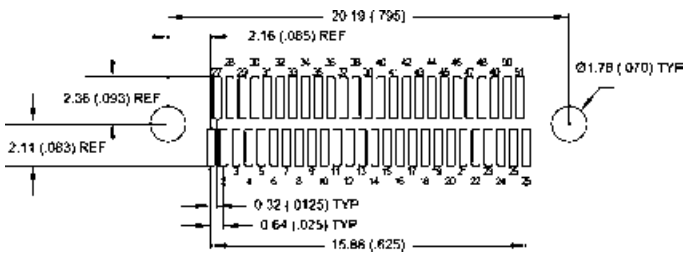

### LAYOUT

#### Suggested PAD configuration

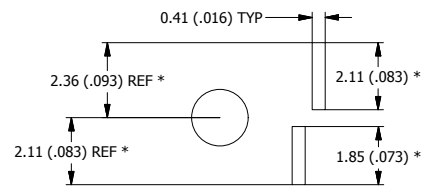

\*: For .040" tail length, add .020" to noted dimensions

# PCB LAYOUT FOR SMV TYPE 0.025" PITCH - MALE CONNECTORS

VIEW A

CONNECTOR  
MATING FACE

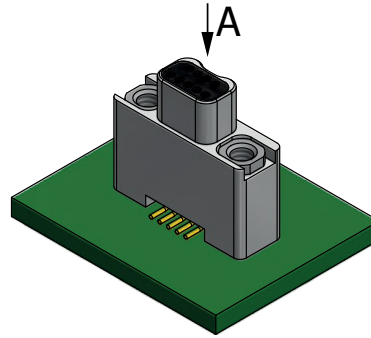
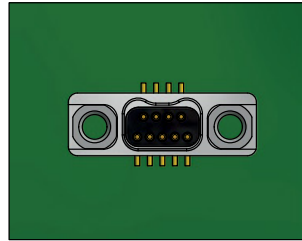

9 CONTACTS - VIEW A

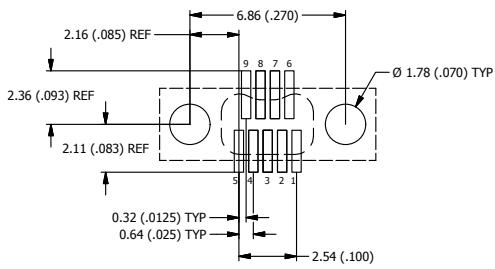

15 CONTACTS - VIEW A

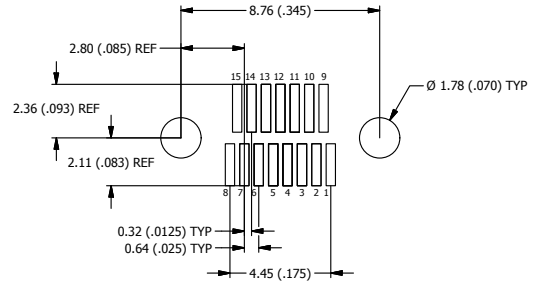

21 CONTACTS - VIEW A

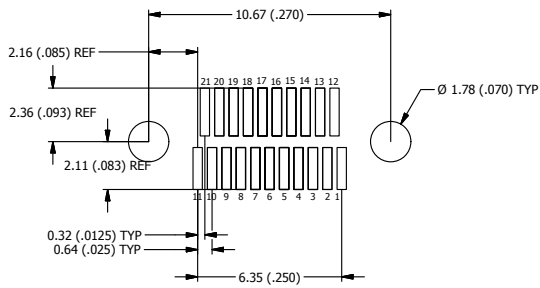

25 CONTACTS - VIEW A

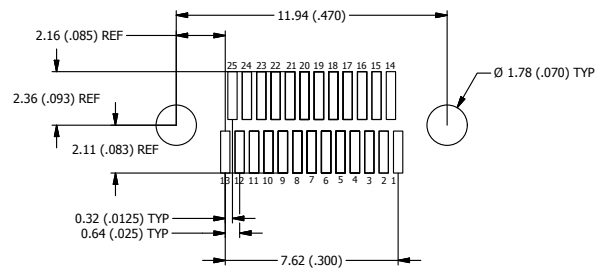

0.635 mm (0.025") pad - contact diameter: AWG 30

# PCB LAYOUT FOR SMV TYPE 0.025" PITCH - MALE CONNECTORS

### 31 CONTACTS - VIEW A

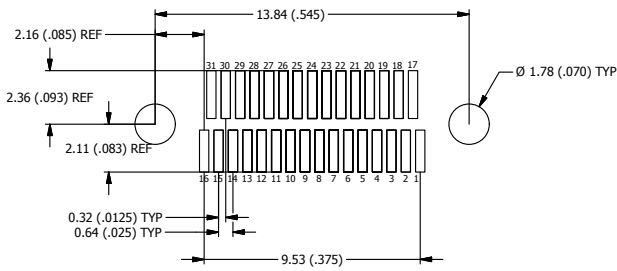

### 37 CONTACTS - VIEW A

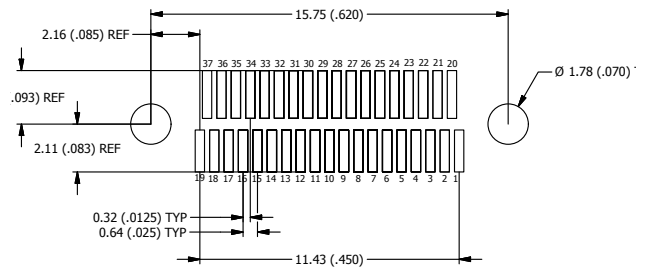

### 51 CONTACTS - VIEW A

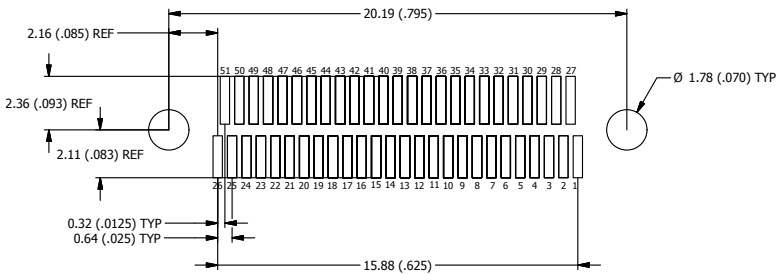

### LAYOUT

#### Suggested PAD configuration

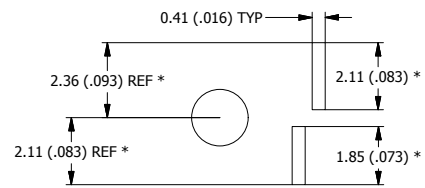

\*: For .040" tail length, add .020" to noted dimensions

# PCB LAYOUT FOR SMH TYPE 0.025" PITCH - FEMALE CONNECTORS

VIEW A

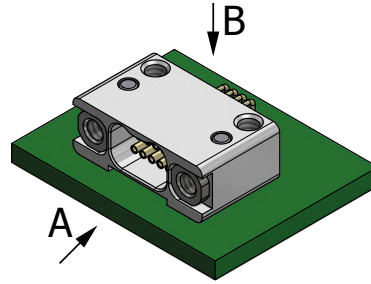
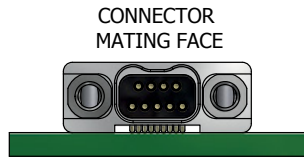

9 CONTACTS - VIEW A

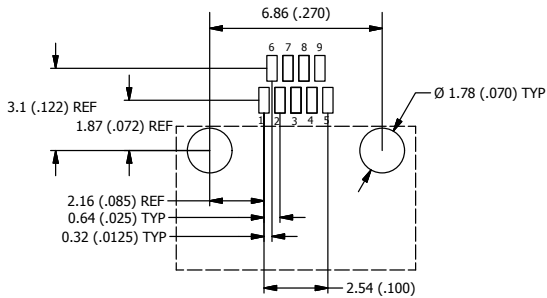

15 CONTACTS - VIEW A

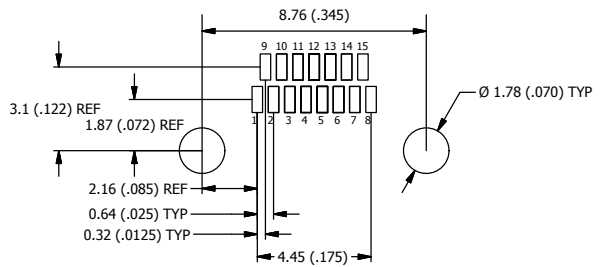

21 CONTACTS - VIEW A

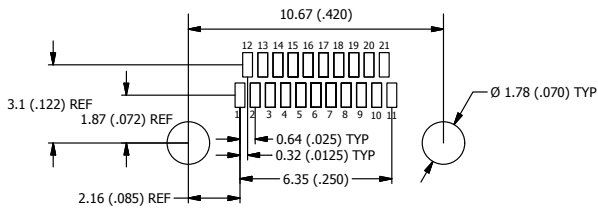

25 CONTACTS - VIEW A

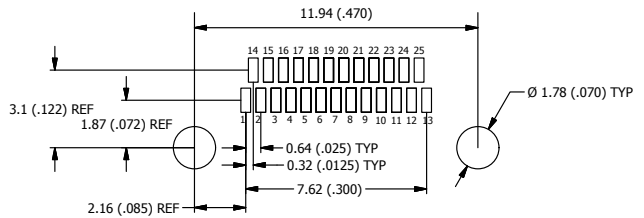

0.635 mm (0.025") pad - contact diameter: AWG 30

# PCB LAYOUT FOR SMH TYPE 0.025" PITCH - FEMALE CONNECTORS

### 31 CONTACTS - VIEW A

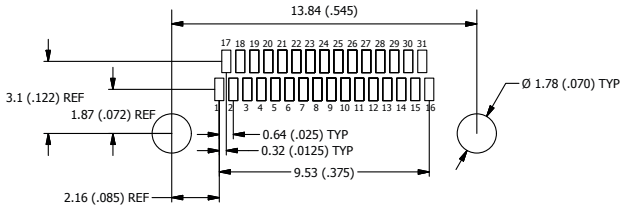

### 37 CONTACTS - VIEW A

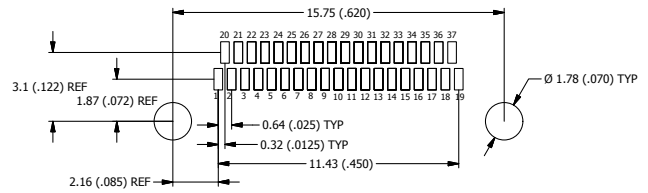

### 51 CONTACTS - VIEW A

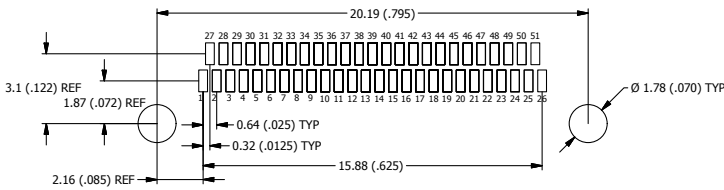

### LAYOUT

Suggested PAD configuration

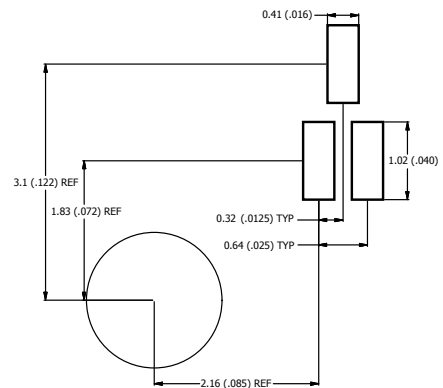

DUAL ROW  
NANO-D CONNECTORS

Nano-D  
connectors

# PCB LAYOUT FOR SMH TYPE 0.025" PITCH - MALE CONNECTORS

VIEW A

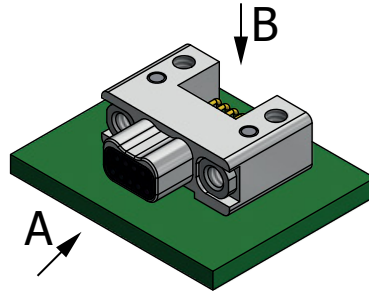
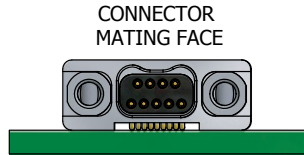

9 CONTACTS - VIEW A

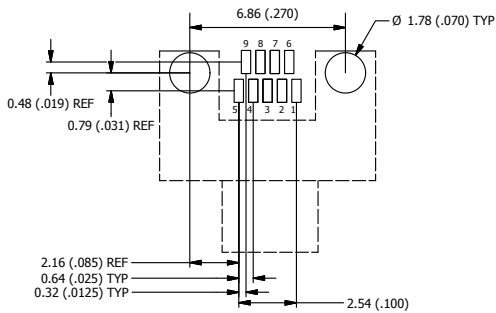

15 CONTACTS - VIEW A

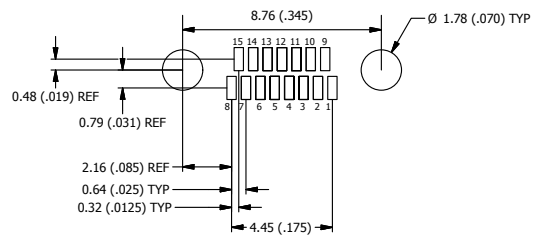

21 CONTACTS - VIEW A

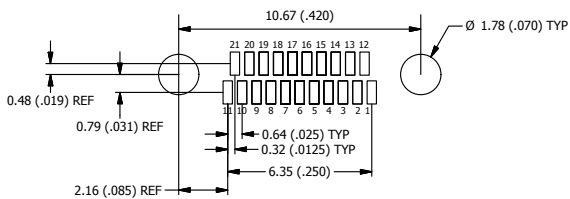

25 CONTACTS - VIEW A

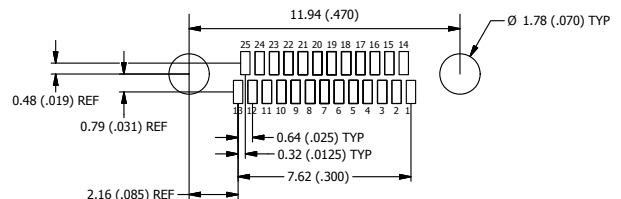

0.635 mm (0.025") pad - contact diameter: AWG 30



# PCB LAYOUT FOR SMH TYPE 0.025" PITCH - MALE CONNECTORS

## 31 CONTACTS - VIEW A

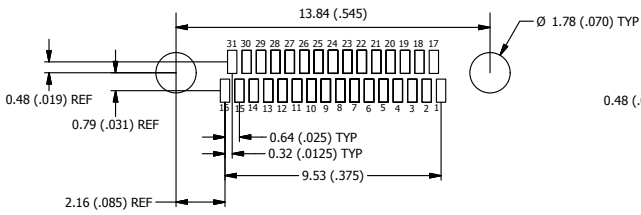

## 37 CONTACTS - VIEW A

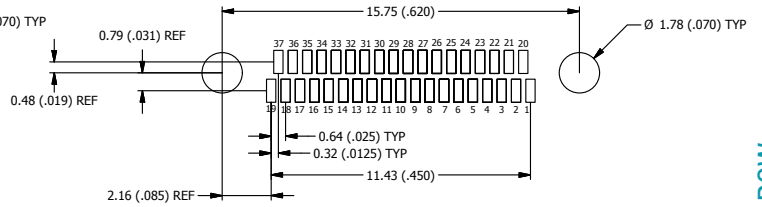

## 51 CONTACTS - VIEW A

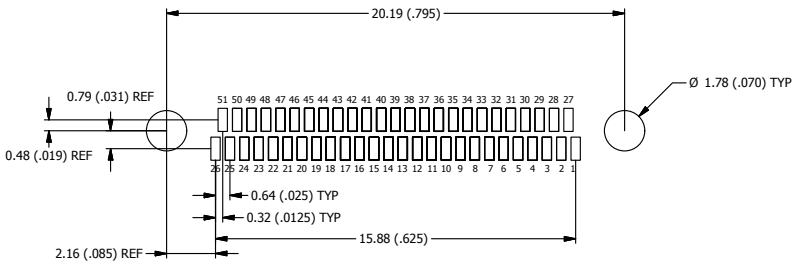

## LAYOUT

Suggested PAD configuration

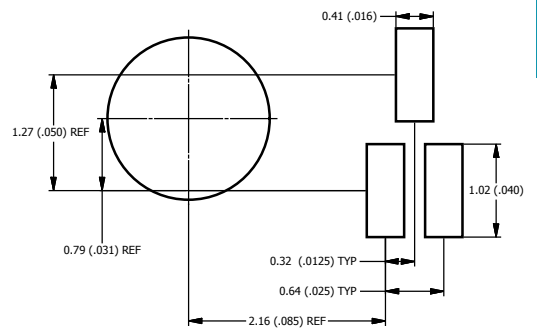

DUAL ROW  
NANO-D CONNECTORS

Nano-D  
connectors



# SINGLE ROW NANO-D CONNECTORS

## RECTANGULAR CONNECTORS FOR CABLES

- Single row pigtail & jumper . . . . . 254

## PCB RECTANGULAR CONNECTORS

- BS (Board Straight) type - 0.050" pitch receptacles . . . . . 256
- BS (Board Straight) type - 0.050" pitch plugs . . . . . 258
- CBR (Condensed Board Right Angle) type - 0.050" pitch receptacles. 260
- CBR (Condensed Board Right Angle) type - 0.050" pitch plugs . . . . . 262
- SMV (Surface Mount Vertical) type - 0.025" pitch receptacles. . . . . 264
- SMV (Surface Mount Vertical) type - 0.025" pitch plugs . . . . . 266
- SMH (Surface Mount Horizontal) type - 0.025" pitch receptacles . . . . . 268
- SMH (Surface Mount Horizontal) type - 0.025" pitch plugs . . . . . 270
- *PCB layout for BS type* . . . . . 272
- *PCB layout for CBR type* . . . . . 274
- *PCB layout for SMV type* . . . . . 276
- *PCB layout for SMH type* . . . . . 278

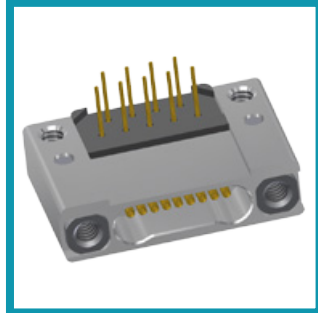

SINGLE ROW  
NANO-D CONNECTORS

Nano-D  
connectors

# SINGLE ROW PIGTAIL & JUMPER

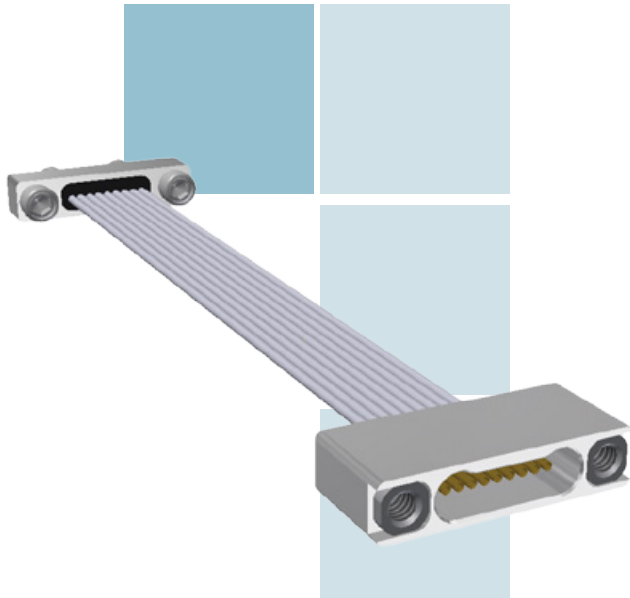

- Reliability for micro-miniature operating systems.
- High performance metal connector and PTFE wire.
  - Operating temperature: 150°C or 200°C.
  - 7 contact arrangements (9 to 51 contacts).

SINGLE ROW  
NANO-D CONNECTORS

Nano-D  
connectors

## IDENTIFICATION CODE

**ND1A 2 15 P S D 1 L 50 R P**

### SERIES

**ND1A:** Nano-D 1-row AXON'.

### CONNECTOR TYPE

**2:** Aluminium with electroless nickel plating and epoxy 150°C.  
**3:** Aluminium with electroless nickel plating and epoxy 200°C.  
 Other materials available on request. (eg Titanium, Stainless Steel).

### NUMBER OF CONTACTS

09, 15, 21, 25, 31, 37, 51. Other versions available on request.

### 1st CONNECTOR TYPE

**P:** Plug connector.  
**S:** Receptacle connector.

### 2nd CONNECTOR TYPE

**P:** Plug connector.  
**S:** Receptacle connector.  
**W:** No second connector - free wires.

### CONNECTIONS (see jumper wiring on page 217)

**D:** Direct pin 1 to pin 1.  
**I:** Indirect (usual for plug-plug jumper).  
**X:** Pigtail.

### WIRE CODE

**1:** ET 3007, AWG 30, 7 strands, 250 V.  
**2:** ET 3207, AWG 32, 7 strands, 250 V.  
**3:** ET 3407, AWG 34, 7 strands, 250 V.  
**4:** ET 3607, AWG 36, 7 strands, 250 V.  
 Other versions available on request.

### COLOUR CODE

**L:** White  
**F:** Yellow.  
**W:** 10 colour repeat.  
 See page 215 for colour code.

### WIRE LENGTH (cm)

Attention! Wire length in centimetres - (1cm = 10 mm = .394").

L	2 ≤ L ≤ 10	10 < L ≤ 100	L > 100
in cm (inches)	0.79 ≤ L ≤ 3.940	3.940 < L ≤ 39.40	39.40
TOLERANCE	-0 / +0.5	-0 / +3	-0 / +5
in cm (inches)	-0 / +0.200	-0 / +1.180	-0 / +1.970

### HARDWARE 1st CONNECTOR

**P:** Threaded hole #0-80 UNF (non removable jackposts, recommended for receptacles).  
**R:** Retractable short hex socket head jackscrews #0-80 UNF (recommended for plugs).  
**L:** Short hex socket head jackscrews #0-80 UNF (captivated).  
**B:** No hardware.

### HARDWARE 2nd CONNECTOR

See above.  
**X:** Pigtail.

IN BOLD: FACTORY STANDARD

# DIMENSIONS

Dimensions are in millimetres (inches).

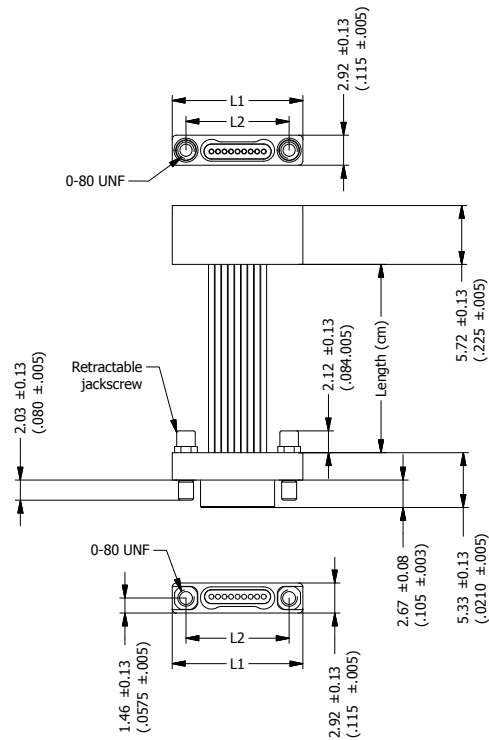

SINGLE ROW  
NANO-D CONNECTORS

Nano-D  
connectors

## SPECIFIC HARDWARE CONFIGURATION

Treaded holes  
#0-80 UNF  
for plug shell  
(code: P)

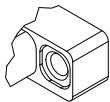

Jackscrew  
#0-80 UNF  
for socket shell  
(code: R/L)

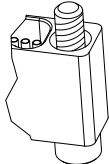

SHELL SIZE	L1 ±0.13 (±.005)	L2 ±0.13 (±.005)
9 S / 9 P	12.70 .500	10.03 .395
15 S / 15 P	16.51 .650	13.84 .545
21 S / 21 P	20.32 .800	17.65 .695
25 S / 25 P	22.86 .900	20.19 .795
31 S / 31 P	26.67 1.050	24.00 .945
37 S / 37 P	30.48 1.200	27.81 1.095
51 S / 51 P	39.37 1.550	36.70 1.445

## SUMMARY OF CHARACTERISTICS

ELECTRICAL & MECHANICAL PERFORMANCE		MATERIAL & FINISH	
CURRENT RATING	1 A max.	SHELL	Aluminium alloy 6061 or 300 series stainless steel or titanium alloy, see ordering for plating options
CONTACT RESISTANCE	71 mΩ max.	INSULATOR	Liquid Crystal Polymer (LCP) or PEEK
INSULATION RESISTANCE	5000 MΩ min. @ 100 Vdc	CONTACT	Precious gold alloy
DIELECTRIC WITHSTANDING VOLTAGE	Sea level: 250 VAc Altitude 21 km (70,000 ft): 100 VAc	ENCAPSULANT	Epoxy Resin
CONTACT ENGAGING FORCE	141 g max. (5 oz)	HARDWARE	300 series stainless steel, passivated
CONTACT SEPARATING FORCE	11 g min. (0.4 oz)		
CONTACT RETENTION	0.9 kg (2 lbs)		
DURABILITY	200 mating cycles min.		
VIBRATION	20g's - No discontinuity > 1 μs		
SHOCK	100g's - No discontinuity > 1 μs		

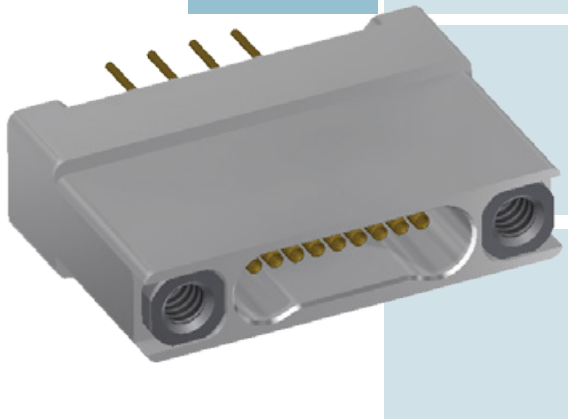

PCB RECTANGULAR CONNECTORS

# BS TYPE

## SINGLE ROW VERTICAL PCB RECEPTACLE

0.050" PITCH

- Reliability for micro-miniature operating systems.
- Several tail lengths available.
- Operating temperature: 150°C or 200°C.
- 7 contact arrangements (9 to 51 contacts).

Nano-D  
connectors

### IDENTIFICATION CODE



**SERIES**

**ND1A:** Nano-D 1-row AXON'.

**CONNECTOR TYPE**

**2:** Aluminium with electroless nickel plating and epoxy 150°C.  
**3:** Aluminium with electroless nickel plating and epoxy 200°C.  
 Other materials available on request. (eg Titanium, Stainless Steel).

**NUMBER OF CONTACTS**

**09, 15, 21, 25, 31, 37, 51.**  
 Other versions available on request.

**CONNECTOR TYPE**

**S:** Receptacle connector.

**FAMILY**

**BS:** AXON' Vertical PCB connector.

**HARDWARE**

**P:** Threaded hole #0-80 UNF (non removable jackposts).  
 Other versions available on request.

**TAIL PLATING**

**G:** Gold.  
 Other tail plating available on request.

**TAIL LENGTH**

**1:** 2.77 mm (0.109").  
**2:** 3.56 mm (0.140").  
**3:** 4.37 mm (0.172").  
**4:** 2.29 mm (0.090").  
 Tolerance: ± 0.25 mm (0.010").

Connectors are supplied with #0-80 UNF screws 1/4" long (for PCB mounting).

IN BOLD: FACTORY STANDARD

# DIMENSIONS

Dimensions are in millimetres (inches).

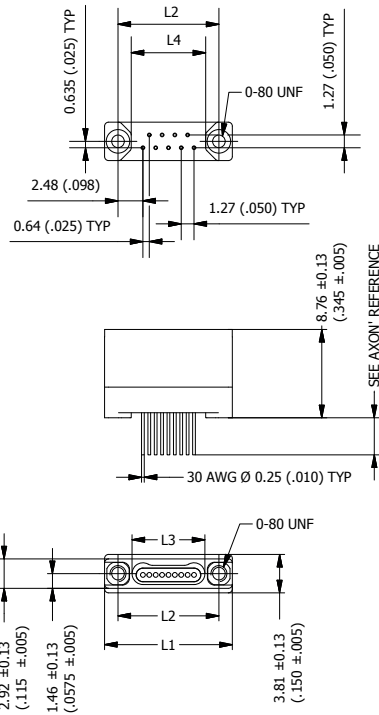

SEE CONTACT LAYOUT ON PCB PAGE 272

SHELL SIZE	L1 ±0.13 (±.005)	L2 ±0.13 (±.005)	L3 ±0.13 (±.005)	L4 ±0.13 (±.005)
9 S	12.70 .500	10.03 .395	7.24 .285	7.37 .290
15 S	16.51 .650	13.84 .545	11.05 .435	11.18 .440
21 S	20.32 .800	17.65 .695	14.86 .585	14.99 .590
25 S	22.86 .900	20.19 .795	17.40 .685	17.53 .690
31 S	26.67 1.050	24.00 .945	21.21 .835	21.34 .840
37 S	30.48 1.200	27.81 1.095	25.02 .985	25.15 .990
51 S	39.37 1.550	36.70 1.445	33.91 1.335	34.04 1.340

## SUMMARY OF CHARACTERISTICS

ELECTRICAL & MECHANICAL PERFORMANCE	
CURRENT RATING	1 A max.
CONTACT RESISTANCE	71 mΩ max.
INSULATION RESISTANCE	5000 MΩ min. @ 100 Vdc
DIELECTRIC WITHSTANDING VOLTAGE	Sea level: 250 VAc Altitude 21 km (70,000 ft): 100 VAc
CONTACT ENGAGING FORCE	141 g max. (5 oz)
CONTACT SEPARATING FORCE	11 g min. (0.4 oz)
CONTACT RETENTION	0.9 kg (2 lbs)
DURABILITY	200 mating cycles min.
VIBRATION	20g's – No discontinuity > 1 μs
SHOCK	100g's – No discontinuity > 1 μs

MATERIAL & FINISH	
SHELL	Aluminium alloy 6061 or 300 series stainless steel or titanium alloy, see ordering for plating options
INSULATOR	Liquid Crystal Polymer (LCP) or PEEK
CONTACT	Copper alloy, gold over nickel plating
ENCAPSULANT	Epoxy Resin
PCB TERMINALS	Gold plated solid copper alloy wire
HARDWARE	300 series stainless steel, passivated

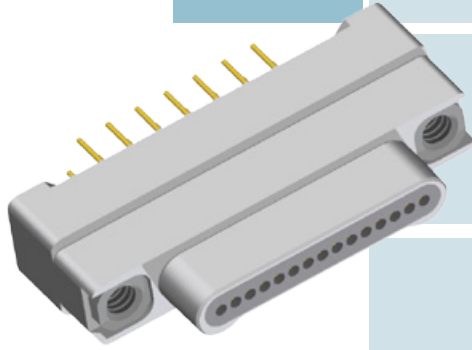

PCB RECTANGULAR CONNECTORS

# BS TYPE

## SINGLE ROW VERTICAL PCB PLUG

### 0.050" PITCH

- Reliability for micro-miniature operating systems.
- Several tail lengths available.
- Operating temperature: 150°C or 200°C.
- 7 contact arrangements (9 to 51 contacts).

### IDENTIFICATION CODE

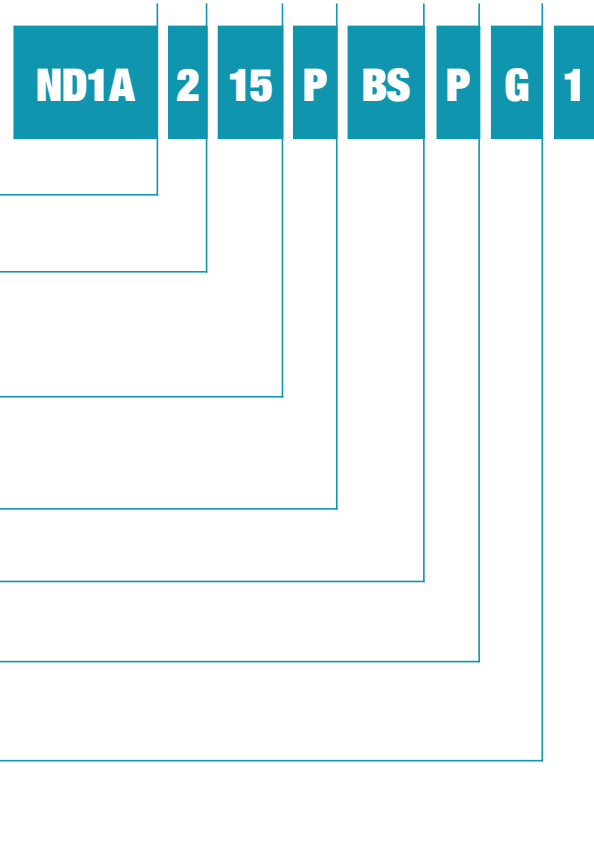

**SERIES**

**ND1A:** Nano-D 1-row AXON'.

**CONNECTOR TYPE**

- 2:** Aluminium with electroless nickel plating and epoxy 150°C.
  - 3:** Aluminium with electroless nickel plating and epoxy 200°C.
- Other materials available on request. (eg Titanium, Stainless Steel).

**NUMBER OF CONTACTS**

**09, 15, 21, 25, 31, 37, 51.**  
Other versions available on request.

**CONNECTOR TYPE**

**P:** Plug connector.

**FAMILY**

**BS:** AXON' Vertical PCB connector.

**HARDWARE**

**P:** Threaded hole #0-80 UNF (non removable jackposts).  
Other versions available on request.

**TAIL PLATING**

**G:** Gold.  
Other tail plating available on request.

**TAIL LENGTH**

- 1:** 2.77 mm (0.109").
  - 2:** 3.56 mm (0.140").
  - 3:** 4.37 mm (0.172").
  - 4:** 2.29 mm (0.090").
- Tolerance: ± 0.25 mm (0.010").

Connectors are supplied with #0-80 UNF screws 1/4" long (for PCB mounting).

IN BOLD: FACTORY STANDARD



# DIMENSIONS

Dimensions are in millimetres (inches).

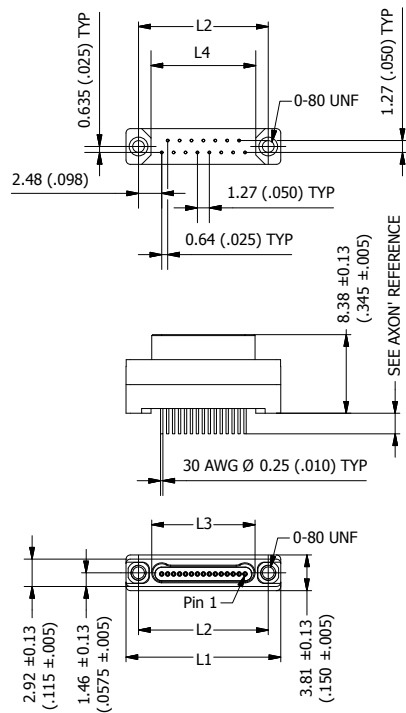

SEE CONTACT LAYOUT ON PCB PAGE 273

SHELL SIZE	L1 ±0.13 (±.005)	L2 ±0.13 (±.005)	L3 ±0.13 (±.005)	L4 ±0.13 (±.005)
9 P	12.70 .500	10.03 .395	7.21 .284	7.37 .290
15 P	16.51 .650	13.84 .545	11.02 .434	11.18 .440
21 P	20.32 .800	17.65 .695	14.83 .584	14.99 .590
25 P	22.86 .900	20.19 .795	17.37 .684	17.53 .690
31 P	26.67 1.050	24.00 .945	21.18 .834	21.34 .840
37 P	30.48 1.200	27.81 1.095	24.99 .984	25.15 .990
51 P	39.37 1.550	36.70 1.445	33.88 1.334	34.04 1.340

## SUMMARY OF CHARACTERISTICS

ELECTRICAL & MECHANICAL PERFORMANCE		MATERIAL & FINISH	
CURRENT RATING	1 A max.	SHELL	Aluminium alloy 6061 or 300 series stainless steel or titanium alloy, see ordering for plating options
CONTACT RESISTANCE	71 mΩ max.	INSULATOR	Liquid Crystal Polymer (LCP) or PEEK
INSULATION RESISTANCE	5000 MΩ min. @ 100 Vdc	CONTACT	Precious gold alloy
DIELECTRIC WITHSTANDING VOLTAGE	Sea level: 250 Vac Altitude 21 km (70,000 ft): 100 Vac	ENCAPSULANT	Epoxy Resin
CONTACT ENGAGING FORCE	141 g max. (5 oz)	PCB TERMINALS	Gold plated solid copper alloy wire
CONTACT SEPARATING FORCE	11 g min. (0.4 oz)	HARDWARE	300 series stainless steel, passivated
CONTACT RETENTION	0.9 kg (2 lbs)		
DURABILITY	200 mating cycles min.		
VIBRATION	20g's – No discontinuity > 1 μs		
SHOCK	100g's – No discontinuity > 1 μs		

# CBR TYPE

## SINGLE ROW RIGHT ANGLE PCB RECEPTACLE

0.050" PITCH

- Reliability for micro-miniature operating systems.
- Several tail lengths available.
- Operating temperature: 150°C or 200°C.
- 7 contact arrangements (9 to 51 contacts).

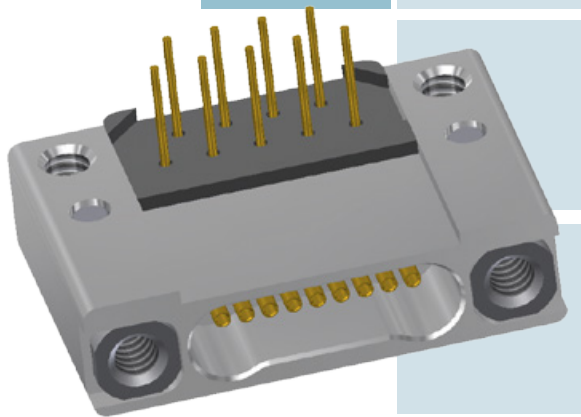

SINGLE ROW  
NANO-D CONNECTORS

Nano-D  
connectors

### IDENTIFICATION CODE

ND1A	2	09	S	CBR	P	G	1
------	---	----	---	-----	---	---	---

**SERIES**

**ND1A:** Nano-D 1-row AXON'.

**CONNECTOR TYPE**

- 2:** Aluminium with electroless nickel plating and epoxy 150°C.
  - 3:** Aluminium with electroless nickel plating and epoxy 200°C.
- Other materials available on request. (eg Titanium, Stainless Steel).

**NUMBER OF CONTACTS**

**09, 15, 21, 25, 31, 37, 51.**  
Other versions available on request.

**CONNECTOR TYPE**

**S:** Receptacle connector.

**FAMILY**

**CBR:** AXON' Right Angle PCB connector.

**HARDWARE**

**P:** Threaded hole #0-80 UNF (non removable jackposts).  
**B:** None.  
Other versions available on request.

**TAIL PLATING**

**G:** Gold.  
Other tail plating available on request.

**TAIL LENGTH**

- 1:** 2.77 mm (0.109").
  - 2:** 3.56 mm (0.140").
  - 3:** 4.37 mm (0.172").
  - 4:** 2.29 mm (0.090").
- Tolerance: ± 0.25 mm (0.010").

Connectors are supplied with #0-80 UNF screws 1/4" long (for PCB mounting).

IN BOLD: FACTORY STANDARD

# DIMENSIONS

Dimensions are in millimetres (inches).

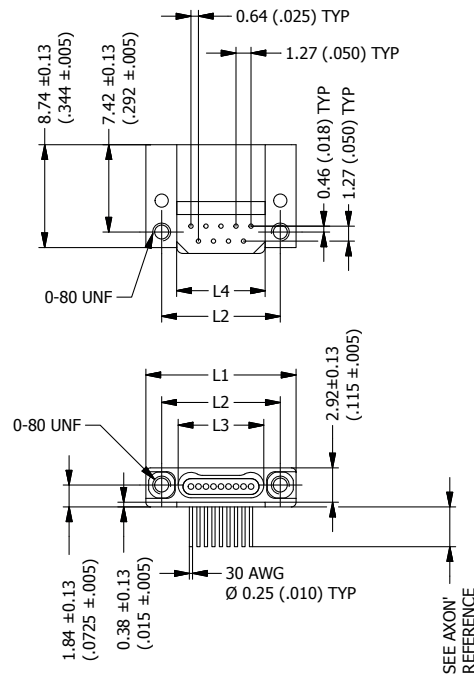

SEE CONTACT LAYOUT ON PCB PAGE 274

SHELL SIZE	L1 ±0.13 (±.005)	L2 ±0.13 (±.005)	L3 ±0.13 (±.005)	L4 ±0.13 (±.005)
9 S	12.70 .500	10.03 .395	7.24 .285	7.37 .290
15 S	16.51 .650	13.84 .545	11.05 .435	11.18 .440
21 S	20.32 .800	17.65 .695	14.86 .585	14.99 .590
25 S	22.86 .900	20.19 .795	17.40 .685	17.53 .690
31 S	26.67 1.050	24.00 .945	21.21 .835	21.34 .840
37 S	30.48 1.200	27.81 1.095	25.02 .985	25.15 .990
51 S	39.37 1.550	36.70 1.445	33.91 1.335	34.04 1.340

## SUMMARY OF CHARACTERISTICS

ELECTRICAL & MECHANICAL PERFORMANCE		MATERIAL & FINISH	
CURRENT RATING	1 A max.	SHELL	Aluminium alloy 6061 or 300 series stainless steel or titanium alloy, see ordering for plating options
CONTACT RESISTANCE	71 mΩ max.	INSULATOR	Liquid Crystal Polymer (LCP) or PEEK
INSULATION RESISTANCE	5000 MΩ min. @ 100 Vdc	CONTACT	Copper alloy, gold over nickel plating
DIELECTRIC WITHSTANDING VOLTAGE	Sea level: 250 Vac Altitude 21 km (70,000 ft): 100 Vac	ENCAPSULANT	Epoxy Resin
CONTACT ENGAGING FORCE	141 g max. (5 oz)	PCB TERMINALS	Gold plated solid copper alloy wire
CONTACT SEPARATING FORCE	11 g min. (0.4 oz)	HARDWARE	300 series stainless steel, passivated
CONTACT RETENTION	0.9 kg (2 lbs)		
DURABILITY	200 mating cycles min.		
VIBRATION	20g's – No discontinuity > 1 μs		
SHOCK	100g's – No discontinuity > 1 μs		

# CBR TYPE

## SINGLE ROW RIGHT ANGLE PCB PLUG

0.050" PITCH

- Reliability for micro-miniature operating systems.
- Several tail lengths available.
- Operating temperature: 150°C or 200°C.
- 7 contact arrangements (9 to 51 contacts).

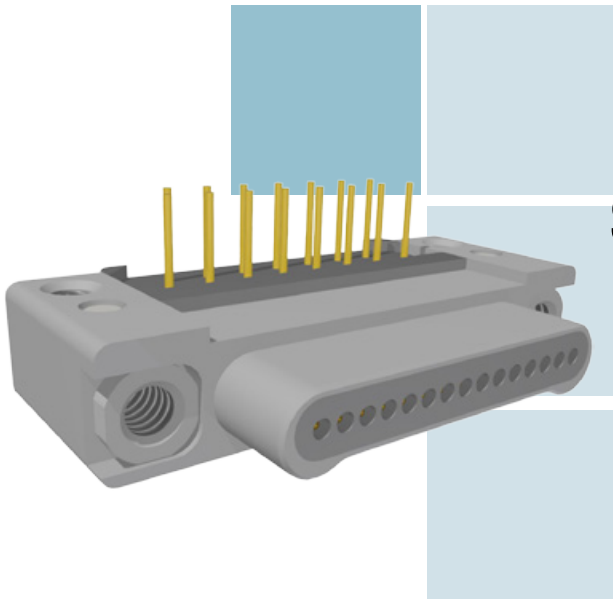

SINGLE ROW  
NANO-D CONNECTORS

Nano-D  
connectors

### IDENTIFICATION CODE

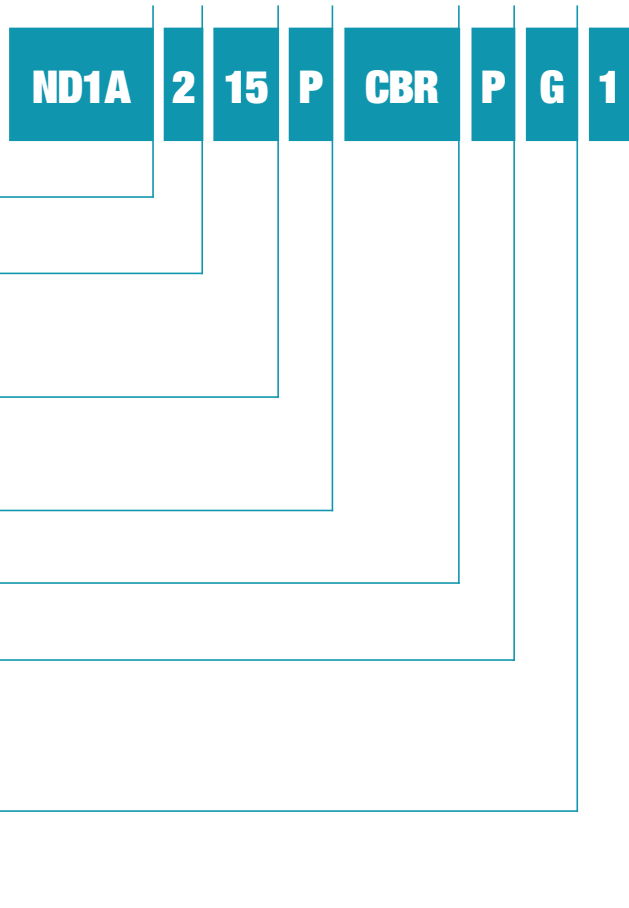

**SERIES**

ND1A: Nano-D 1-row AXON'.

**CONNECTOR TYPE**

**2:** Aluminium with electroless nickel plating and epoxy 150°C.  
**3:** Aluminium with electroless nickel plating and epoxy 200°C.  
 Other materials available on request. (eg Titanium, Stainless Steel).

**NUMBER OF CONTACTS**

**09, 15, 21, 25, 31, 37, 51.**  
 Other versions available on request.

**CONNECTOR TYPE**

**P:** Plug connector.

**FAMILY**

**CBR:** AXON' Right Angle PCB connector.

**HARDWARE**

**P:** Threaded hole #0-80 UNF (non removable jackposts).  
**B:** None.  
 Other versions available on request.

**TAIL PLATING**

**G:** Gold.  
 Other tail plating available on request.

**TAIL LENGTH**

**1:** 2.77 mm (0.109").  
**2:** 3.56 mm (0.140").  
**3:** 4.37 mm (0.172").  
**4:** 2.29 mm (0.090").  
 Tolerance: ± 0.25 mm (0.010").

Connectors are supplied with #0-80 UNF screws 1/4" long (for PCB mounting).

IN BOLD: FACTORY STANDARD

# DIMENSIONS

Dimensions are in millimetres (inches).

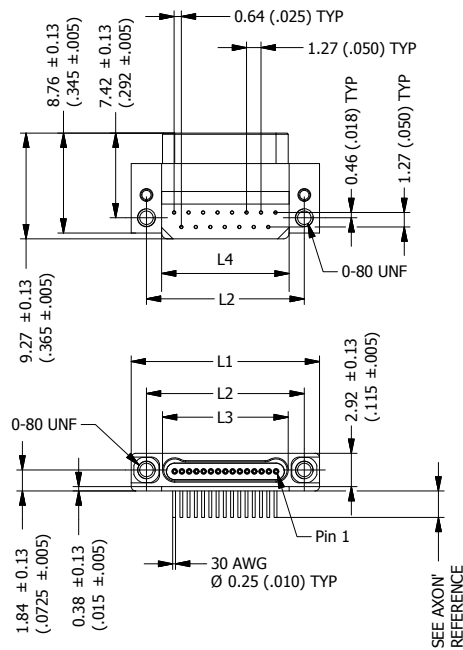

SEE CONTACT LAYOUT ON PCB PAGE 275

SHELL SIZE	L1 ±0.13 (±.005)	L2 ±0.13 (±.005)	L3 ±0.13 (±.005)	L4 ±0.13 (±.005)
9 P	12.70 .500	10.03 .395	7.21 .284	7.37 .290
15 P	16.51 .650	13.84 .545	11.02 .434	11.18 .440
21 P	20.32 .800	17.65 .695	14.83 .584	14.99 .590
25 P	22.86 .900	20.19 .795	17.37 .684	17.53 .690
31 P	26.67 1.050	24.00 .945	21.18 .834	21.34 .840
37 P	30.48 1.200	27.81 1.095	24.99 .984	25.15 .990
51 P	39.37 1.550	36.70 1.445	33.88 1.334	34.04 1.340

## SUMMARY OF CHARACTERISTICS

ELECTRICAL & MECHANICAL PERFORMANCE		MATERIAL & FINISH	
CURRENT RATING	1 A max.	SHELL	Aluminium alloy 6061 or 300 series stainless steel or titanium alloy, see ordering for plating options
CONTACT RESISTANCE	71 mΩ max.	INSULATOR	Liquid Crystal Polymer (LCP) or PEEK
INSULATION RESISTANCE	5000 MΩ min. @ 100 Vdc	CONTACT	Precious gold alloy
DIELECTRIC WITHSTANDING VOLTAGE	Sea level: 250 Vac Altitude 21 km (70,000 ft): 100 Vac	ENCAPSULANT	Epoxy Resin
CONTACT ENGAGING FORCE	141 g max. (5 oz)	PCB TERMINALS	Gold plated solid copper alloy wire
CONTACT SEPARATING FORCE	11 g min. (0.4 oz)	HARDWARE	300 series stainless steel, passivated
CONTACT RETENTION	0.9 kg (2 lbs)		
DURABILITY	200 mating cycles min.		
VIBRATION	20g's – No discontinuity > 1 μs		
SHOCK	100g's – No discontinuity > 1 μs		

# SMV TYPE

## SINGLE ROW VERTICAL SURFACE MOUNT PCB RECEPTACLE

0.025" PITCH

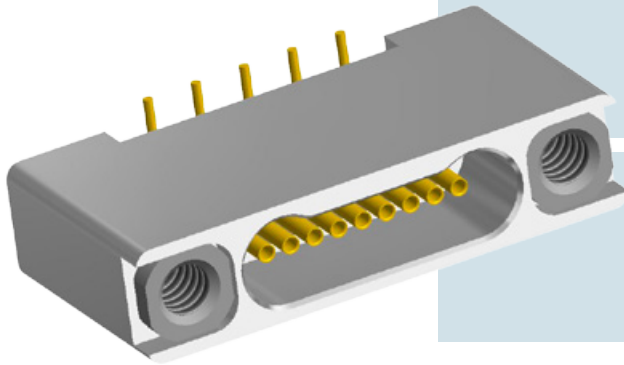

- Reliability for micro-miniature operating systems.
- Surface Mount.
- Several tail lengths available.
- Operating temperature: 150°C or 200°C.
- 7 contact arrangements (9 to 51 contacts).

SINGLE ROW  
NANO-D CONNECTORS

Nano-D  
connectors

### IDENTIFICATION CODE

ND1A	2	09	S	SMV	P	G	1
------	---	----	---	-----	---	---	---

**SERIES**

ND1A: Nano-D 1-row AXON'.

**CONNECTOR TYPE**

- 2:** Aluminium with electroless nickel plating and epoxy 150°C.
- 3:** Aluminium with electroless nickel plating and epoxy 200°C.
- Other materials available on request. (eg Titanium, Stainless Steel).

**NUMBER OF CONTACTS**

09, 15, 21, 25, 31, 37, 51.  
Other versions available on request.

**CONNECTOR TYPE**

S: Receptacle connector.

**FAMILY**

SMV: AXON' Vertical surface mount PCB connector.

**HARDWARE**

P: Threaded holes #0-80 UNF (non removable jackposts).  
Other versions available on request.  
B: None.

**TAIL PLATING**

G: Gold, AWG 30.  
Other tail plating available on request.

**TAIL LENGTH**

1: 0.51 mm (0.020").  
2: 1.02 mm (0.040").  
Tolerance: ± 0.25 mm (0.010").

Connectors are supplied with #0-80 UNF screws 1/4" long (for PCB mounting).

IN BOLD: FACTORY STANDARD

# DIMENSIONS

Dimensions are in millimetres (inches).

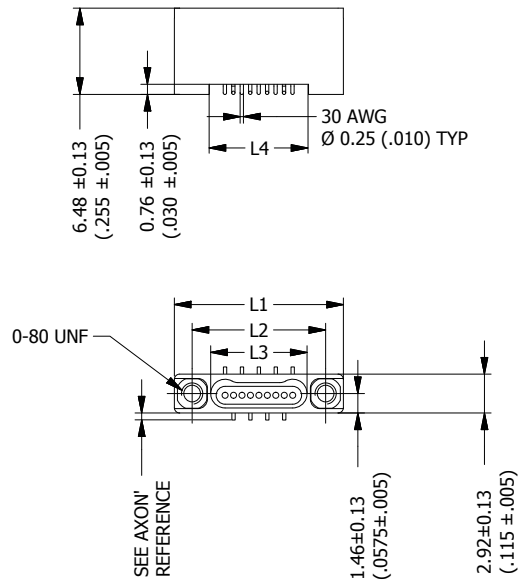

SEE CONTACT LAYOUT ON PCB PAGE 276

SHELL SIZE	L1 $\pm 0.13$ ( $\pm .005$ )	L2 $\pm 0.13$ ( $\pm .005$ )	L3 $\pm 0.13$ ( $\pm .005$ )	L4 $\pm 0.13$ ( $\pm .005$ )
9 S	12.70 .500	10.03 .395	7.24 .285	7.37 .290
15 S	16.51 .650	13.84 .545	11.05 .435	11.18 .440
21 S	20.32 .800	17.65 .695	14.86 .585	14.99 .590
25 S	22.86 .900	20.19 .795	17.40 .685	17.53 .690
31 S	26.67 1.050	24.00 .945	21.21 .835	21.34 .840
37 S	30.48 1.200	27.81 1.095	25.02 .985	25.15 .990
51 S	39.37 1.550	36.70 1.445	33.91 1.335	34.04 1.340

## SUMMARY OF CHARACTERISTICS

ELECTRICAL & MECHANICAL PERFORMANCE		MATERIAL & FINISH	
CURRENT RATING	1 A max.	SHELL	Aluminium alloy 6061 or 300 series stainless steel or titanium alloy, see ordering for plating options
CONTACT RESISTANCE	71 m $\Omega$ max.	INSULATOR	Liquid Crystal Polymer (LCP) or PEEK
INSULATION RESISTANCE	5000 M $\Omega$ min. @ 100 Vdc	CONTACT	Copper alloy, gold over nickel plating
DIELECTRIC WITHSTANDING VOLTAGE	Sea level: 250 V <sub>AC</sub> Altitude 21 km (70,000 ft): 100 V <sub>AC</sub>	ENCAPSULANT	Epoxy Resin
CONTACT ENGAGING FORCE	141 g max. (5 oz)	PCB TERMINALS	Gold plated solid copper alloy wire
CONTACT SEPARATING FORCE	11 g min. (0.4 oz)	HARDWARE	300 series stainless steel, passivated
CONTACT RETENTION	0.9 kg (2 lbs)		
DURABILITY	200 mating cycles min.		
VIBRATION	20g's – No discontinuity > 1 $\mu$ s		
SHOCK	100g's – No discontinuity > 1 $\mu$ s		

SINGLE ROW  
NANO-D CONNECTORS

Nano-D  
connectors

# SMV TYPE

## SINGLE ROW VERTICAL SURFACE MOUNT PCB PLUG

0.025" PITCH

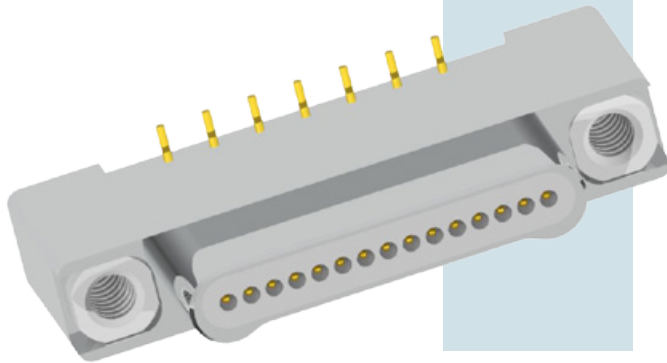

- Reliability for micro-miniature operating systems.
- Surface Mount.
- Several tail lengths available.
- Operating temperature: 150°C or 200°C.
- 7 contact arrangements (9 to 51 contacts).

SINGLE ROW  
NANO-D CONNECTORS

Nano-D  
connectors

### IDENTIFICATION CODE

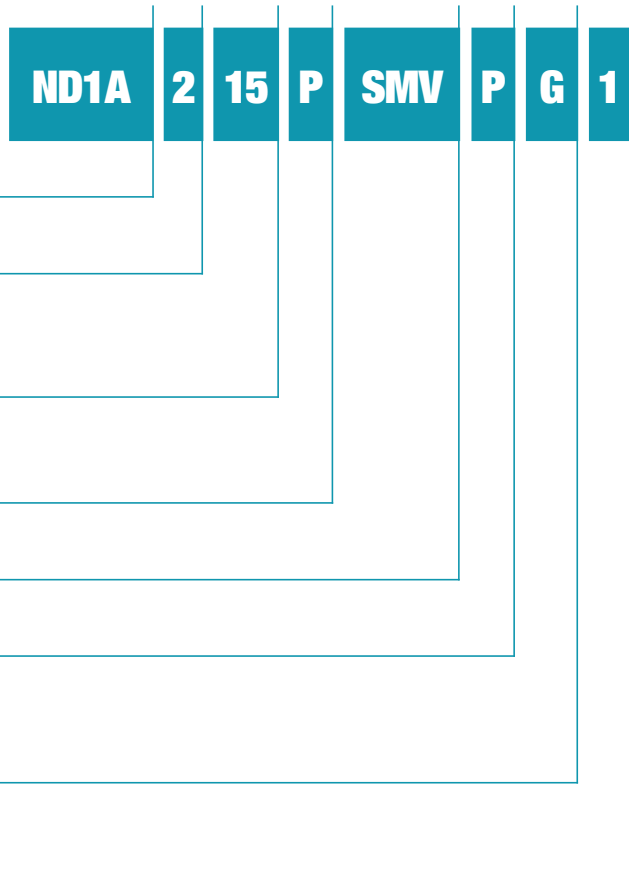

**SERIES**

**ND1A:** Nano-D 1-row AXON'.

**CONNECTOR TYPE**

**2:** Aluminium with electroless nickel plating and epoxy 150°C.  
**3:** Aluminium with electroless nickel plating and epoxy 200°C.  
 Other materials available on request. (eg Titanium, Stainless Steel).

**NUMBER OF CONTACTS**

**09, 15, 21, 25, 31, 37, 51.**  
 Other versions available on request.

**CONNECTOR TYPE**

**P:** Plug connector.

**FAMILY**

**SMV:** AXON' Vertical surface mount PCB connector.

**HARDWARE**

**P:** Threaded holes #0-80 UNF (non removable jackposts).  
 Other versions available on request.  
**B:** None.

**TAIL PLATING**

**G:** Gold, AWG 30.  
 Other tail plating available on request.

**TAIL LENGTH**

**1:** 0.51 mm (0.020").  
**2:** 1.02 mm (0.040").  
 Tolerance: ± 0.25 mm (0.010").

Connectors are supplied with #0-80 UNF screws 1/4" long (for PCB mounting).

IN BOLD: FACTORY STANDARD



# DIMENSIONS

Dimensions are in millimetres (inches).

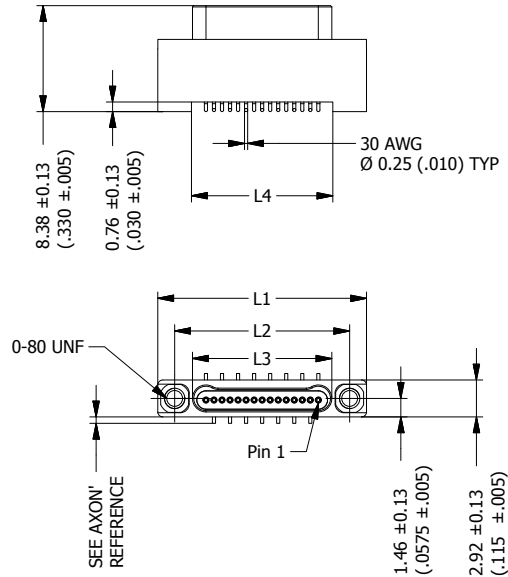

SEE CONTACT LAYOUT ON PCB PAGE 277

SHELL SIZE	L1 $\pm 0.13$ ( $\pm .005$ )	L2 $\pm 0.13$ ( $\pm .005$ )	L3 $\pm 0.13$ ( $\pm .005$ )	L4 $\pm 0.13$ ( $\pm .005$ )
9 P	12.70 .500	10.03 .395	7.21 .284	7.37 .290
15 P	16.51 .650	13.84 .545	11.02 .434	11.18 .440
21 P	20.32 .800	17.65 .695	14.83 .584	14.99 .590
25 P	22.86 .900	20.19 .795	17.37 .684	17.53 .690
31 P	26.67 1.050	24.00 .945	21.18 .834	21.34 .840
37 P	30.48 1.200	27.81 1.095	24.99 .984	25.15 .990
51 P	39.37 1.550	36.70 1.445	33.88 1.334	34.04 1.340

## SUMMARY OF CHARACTERISTICS

ELECTRICAL & MECHANICAL PERFORMANCE		MATERIAL & FINISH	
CURRENT RATING	1 A max.	SHELL	Aluminium alloy 6061 or 300 series stainless steel or titanium alloy, see ordering for plating options
CONTACT RESISTANCE	71 m $\Omega$ max.	INSULATOR	Liquid Crystal Polymer (LCP) or PEEK
INSULATION RESISTANCE	5000 M $\Omega$ min. @ 100 Vdc	CONTACT	Precious gold alloy
DIELECTRIC WITHSTANDING VOLTAGE	Sea level: 250 VAc Altitude 21 km (70,000 ft): 100 VAc	ENCAPSULANT	Epoxy Resin
CONTACT ENGAGING FORCE	141 g max. (5 oz)	PCB TERMINALS	Gold plated solid copper alloy wire
CONTACT SEPARATING FORCE	11 g min. (0.4 oz)	HARDWARE	300 series stainless steel, passivated
CONTACT RETENTION	0.9 kg (2 lbs)		
DURABILITY	200 mating cycles min.		
VIBRATION	20g's - No discontinuity > 1 $\mu$ s		
SHOCK	100g's - No discontinuity > 1 $\mu$ s		

# SMH TYPE

## SINGLE ROW HORIZONTAL SURFACE MOUNT PCB RECEPTACLE

0.025" PITCH

- Reliability for micro-miniature operating systems.
- Surface Mount.
- Operating temperature: 150°C or 200°C.
- 7 contact arrangements (9 to 51 contacts).

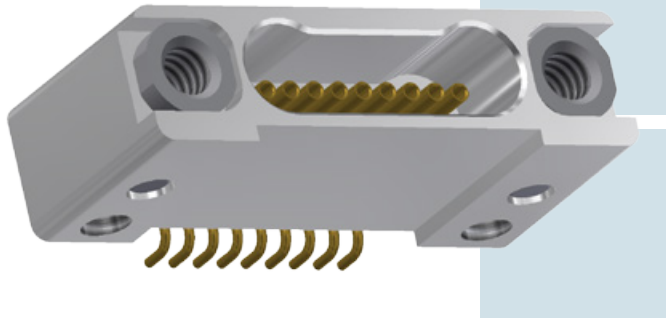

SINGLE ROW  
NANO-D CONNECTORS

Nano-D  
connectors

### IDENTIFICATION CODE

ND1A

2

09

S

SMH

P

G

1

#### SERIES

**ND1A:** Nano-D 1-row AXON'.

#### CONNECTOR TYPE

**2:** Aluminium with electroless nickel plating and epoxy 150°C.

**3:** Aluminium with electroless nickel plating and epoxy 200°C.

Other materials available on request. (eg Titanium, Stainless Steel).

#### NUMBER OF CONTACTS

**09, 15, 21, 25, 31, 37, 51.**

Other versions available on request.

#### CONNECTOR TYPE

**S:** Receptacle connector.

#### FAMILY

**SMH:** AXON' Horizontal surface mount PCB connector.

#### HARDWARE

**P:** Threaded holes #0-80 UNF (non removable jackposts).

Other versions available on request.

**B:** None.

#### TAIL PLATING

**G:** Gold, AWG 30.

Other tail plating available on request.

#### TAIL LENGTH

**1:** Standard.

Connectors are supplied with #0-80 UNF screws 1/4" long (for PCB mounting).

IN BOLD: FACTORY STANDARD

# DIMENSIONS

Dimensions are in millimetres (inches).

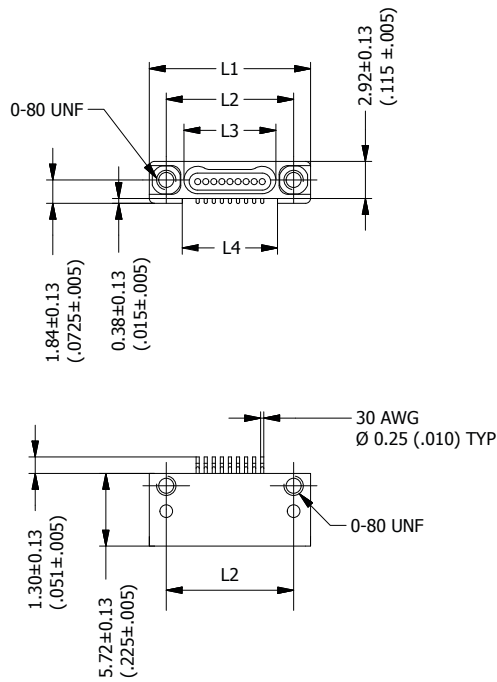

SEE CONTACT LAYOUT ON PCB PAGE 278

SHELL SIZE	L1 ±0.13 (±.005)	L2 ±0.13 (±.005)	L3 ±0.13 (±.005)	L4 ±0.13 (±.005)
9 S	12.70 .500	10.03 .395	7.24 .285	7.37 .290
15 S	16.51 .650	13.84 .545	11.05 .435	11.18 .440
21 S	20.32 .800	17.65 .695	14.86 .585	14.99 .590
25 S	22.86 .900	20.19 .795	17.40 .685	17.53 .690
31 S	26.67 1.050	24.00 .945	21.21 .835	21.34 .840
37 S	30.48 1.200	27.81 1.095	25.02 .985	25.15 .990
51 S	39.37 1.550	36.70 1.445	33.91 1.335	34.04 1.340

## SUMMARY OF CHARACTERISTICS

ELECTRICAL & MECHANICAL PERFORMANCE		MATERIAL & FINISH	
CURRENT RATING	1 A max.	SHELL	Aluminium alloy 6061 or 300 series stainless steel or titanium alloy, see ordering for plating options
CONTACT RESISTANCE	71 mΩ max.	INSULATOR	Liquid Crystal Polymer (LCP) or PEEK
INSULATION RESISTANCE	5000 MΩ min. @ 100 Vdc	CONTACT	Precious gold alloy
DIELECTRIC WITHSTANDING VOLTAGE	Sea level: 250 VAc Altitude 21 km (70,000 ft): 100 VAc	ENCAPSULANT	Epoxy Resin
CONTACT ENGAGING FORCE	141 g max. (5 oz)	PCB TERMINALS	Gold plated solid copper alloy wire
CONTACT SEPARATING FORCE	11 g min. (0.4 oz)	HARDWARE	300 series stainless steel, passivated
CONTACT RETENTION	0.9 kg (2 lbs)		
DURABILITY	200 mating cycles min.		
VIBRATION	20g's – No discontinuity > 1 μs		
SHOCK	100g's – No discontinuity > 1 μs		

# SMH TYPE

## SINGLE ROW HORIZONTAL SURFACE MOUNT PCB PLUG

0.025" PITCH

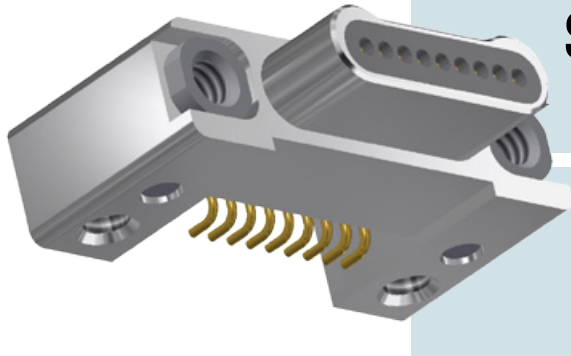

- Reliability for micro-miniature operating systems.
- Surface Mount.
- Operating temperature: 150°C or 200°C.
- 7 contact arrangements (9 to 51 contacts).

SINGLE ROW  
NANO-D CONNECTORS

Nano-D  
connectors

### IDENTIFICATION CODE

ND1A	2	09	P	SMH	P	G	1
------	---	----	---	-----	---	---	---

**SERIES**

**ND1A:** Nano-D 1-row AXON'.

**CONNECTOR TYPE**

- 2:** Aluminium with electroless nickel plating and epoxy 150°C.
  - 3:** Aluminium with electroless nickel plating and epoxy 200°C.
- Other materials available on request. (eg Titanium, Stainless Steel).

**NUMBER OF CONTACTS**

**09, 15, 21, 25, 31, 37, 51.**  
Other versions available on request.

**CONNECTOR TYPE**

**P:** Plug connector.

**FAMILY**

**SMH:** AXON' Horizontal surface mount PCB connector.

**HARDWARE**

**P:** Threaded holes #0-80 UNF (non removable jackposts).  
Other versions available on request.  
**B:** None.

**TAIL PLATING**

**G:** Gold, AWG 30.  
Other tail plating available on request.

**TAIL LENGTH**

**1:** Standard.

Connectors are supplied with #0-80 UNF screws 1/4" long (for PCB mounting).

IN BOLD: FACTORY STANDARD

# DIMENSIONS

Dimensions are in millimetres (inches).

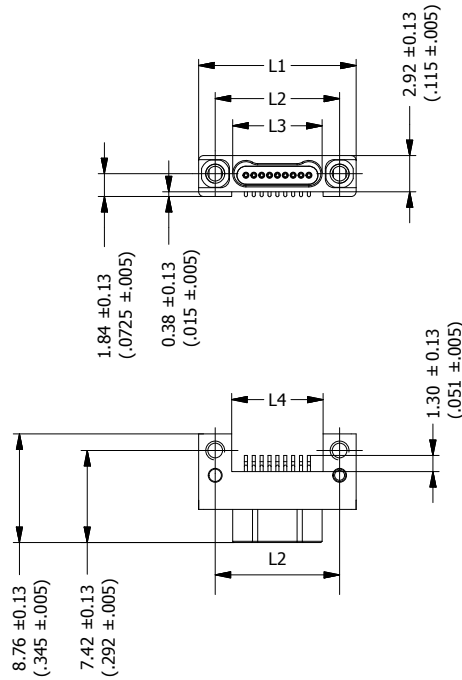

SEE CONTACT LAYOUT ON PCB PAGE 279

SHELL SIZE	L1 ±0.13 (±.005)	L2 ±0.13 (±.005)	L3 ±0.13 (±.005)	L4 ±0.13 (±.005)
9 P	12.70 .500	10.03 .395	7.21 .284	7.37 .290
15 P	16.51 .650	13.84 .545	11.02 .434	11.18 .440
21 P	20.32 .800	17.65 .695	14.83 .584	14.99 .590
25 P	22.86 .900	20.19 .795	17.37 .684	17.53 .690
31 P	26.67 1.050	24.00 .945	21.18 .834	21.34 .840
37 P	30.48 1.200	27.81 1.095	24.99 .984	25.15 .990
51 P	39.37 1.550	36.70 1.445	33.88 1.334	34.04 1.340

## SUMMARY OF CHARACTERISTICS

ELECTRICAL & MECHANICAL PERFORMANCE	
CURRENT RATING	1 A max.
CONTACT RESISTANCE	71 mΩ max.
INSULATION RESISTANCE	5000 MΩ min. @ 100 Vdc
DIELECTRIC WITHSTANDING VOLTAGE	Sea level: 250 Vac
	Altitude 21 km (70,000 ft): 100 Vac
CONTACT ENGAGING FORCE	141 g max. (5 oz)
CONTACT SEPARATING FORCE	11 g min. (0.4 oz)
CONTACT RETENTION	0.9 kg (2 lbs)
DURABILITY	200 mating cycles min.
VIBRATION	20g's – No discontinuity > 1 μs
SHOCK	100g's – No discontinuity > 1 μs

MATERIAL & FINISH	
SHELL	Aluminium alloy 6061 or 300 series stainless steel or titanium alloy, see ordering for plating options
INSULATOR	Liquid Crystal Polymer (LCP) or PEEK
CONTACT	Precious gold alloy
ENCAPSULANT	Epoxy Resin
PCB TERMINALS	Gold plated solid copper alloy wire
HARDWARE	300 series stainless steel, passivated

SINGLE ROW  
NANO-D CONNECTORS

Nano-D  
connectors

# PCB LAYOUT FOR BS TYPE 0.050" PITCH - FEMALE CONNECTORS

VIEW A

CONNECTOR  
MATING FACE

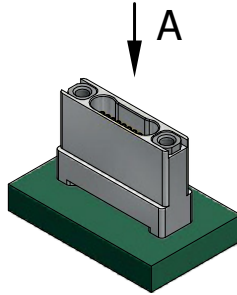
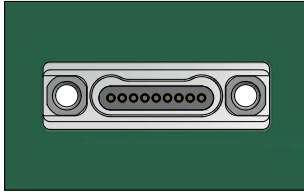

9 CONTACTS - VIEW A

PCB  
BOARD LAYOUT

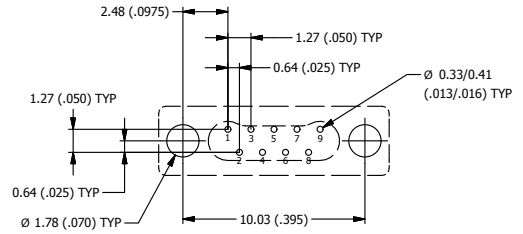

15 CONTACTS - VIEW A

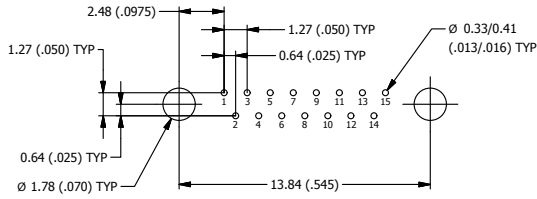

21 CONTACTS - VIEW A

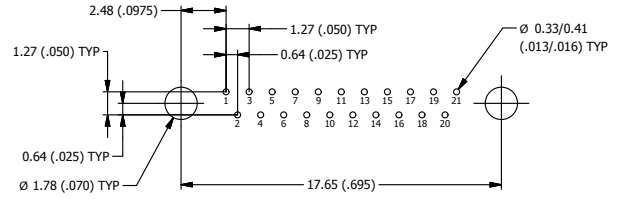

25 CONTACTS - VIEW A

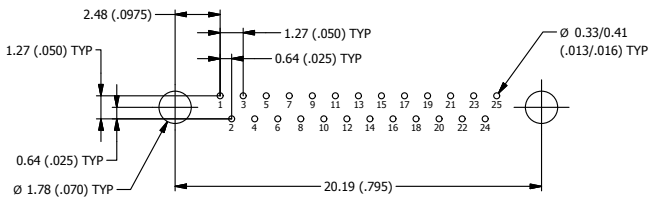

31 CONTACTS - VIEW A

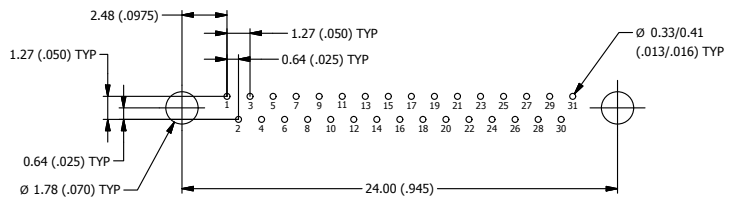

37 CONTACTS - VIEW A

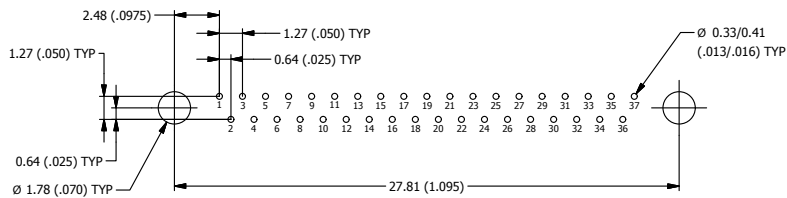

51 CONTACTS - VIEW A

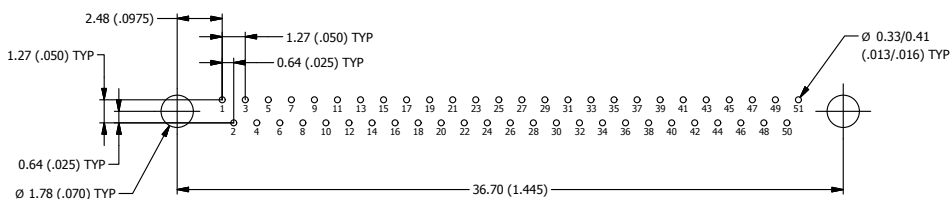

# PCB LAYOUT FOR BS TYPE 0.050" PITCH - MALE CONNECTORS

**VIEW A**

CONNECTOR  
MATING FACE

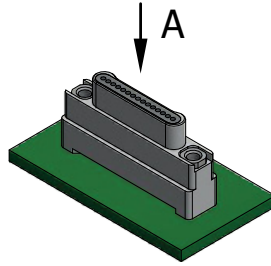
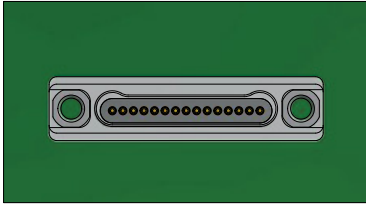

**9 CONTACTS - VIEW A**

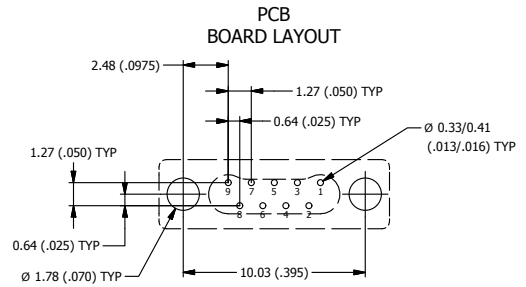

**15 CONTACTS - VIEW A**

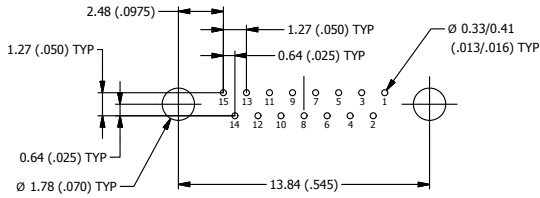

**21 CONTACTS - VIEW A**

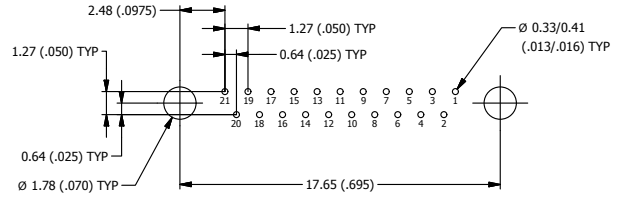

**25 CONTACTS - VIEW A**

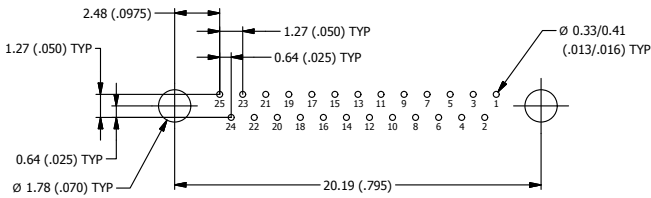

**31 CONTACTS - VIEW A**

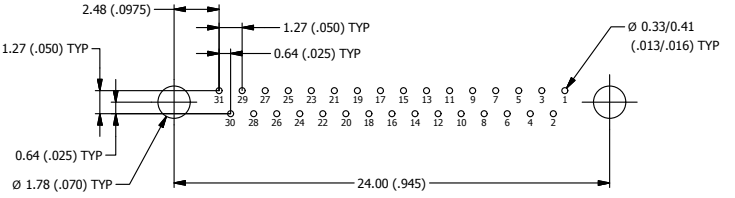

**37 CONTACTS - VIEW A**

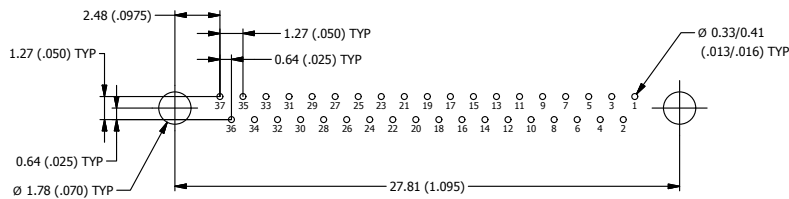

**51 CONTACTS - VIEW A**

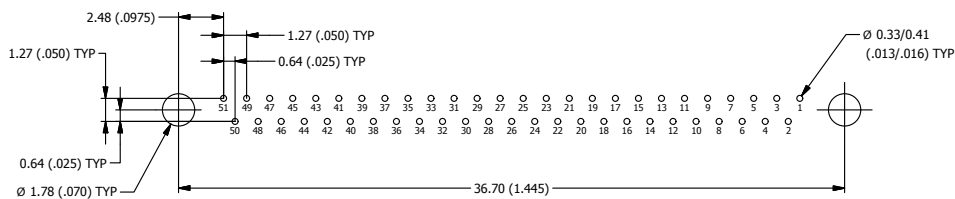

SINGLE ROW  
NANO-D CONNECTORS

Nano-D  
connectors

# PCB LAYOUT FOR CBR TYPE 0.050" PITCH - FEMALE CONNECTORS

## 9 CONTACTS - VIEW A

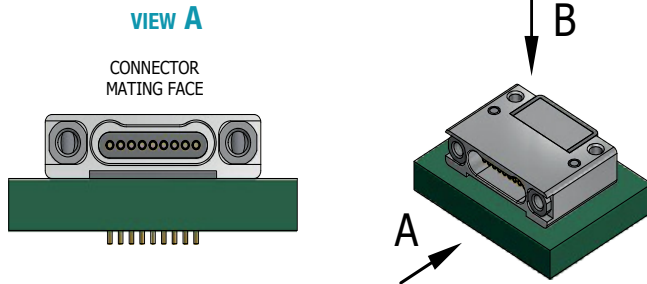

PCB BOARD LAYOUT

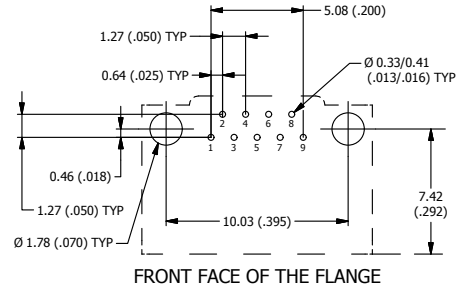

## 15 CONTACTS - VIEW A

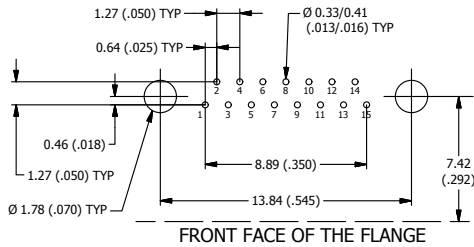

## 21 CONTACTS - VIEW A

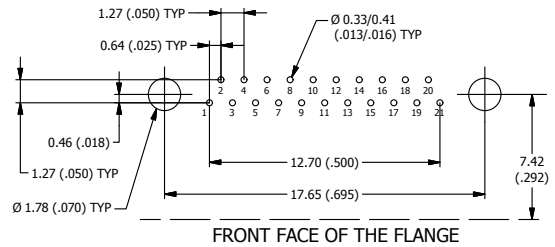

## 25 CONTACTS - VIEW A

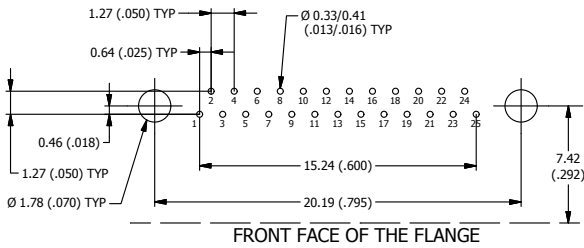

## 31 CONTACTS - VIEW A

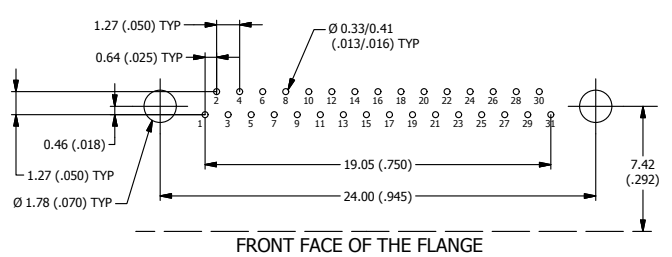

## 37 CONTACTS - VIEW A

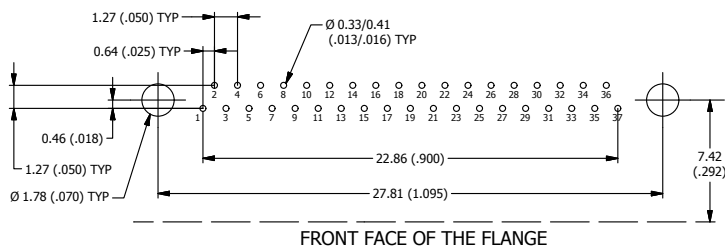

## 51 CONTACTS - VIEW A

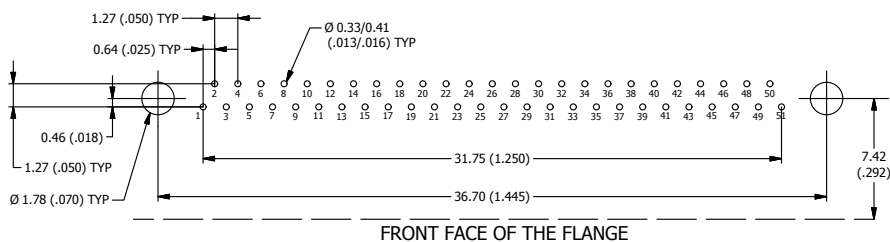



# PCB LAYOUT FOR CBR TYPE 0.050" PITCH - MALE CONNECTORS

## 9 CONTACTS - VIEW A

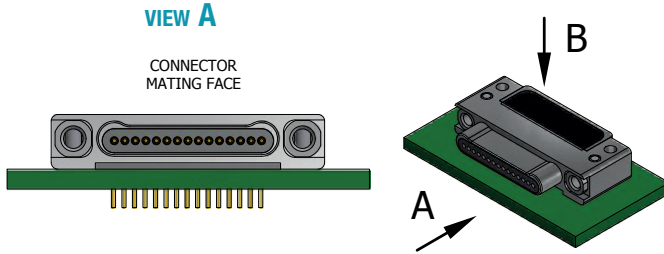

PCB  
BOARD LAYOUT

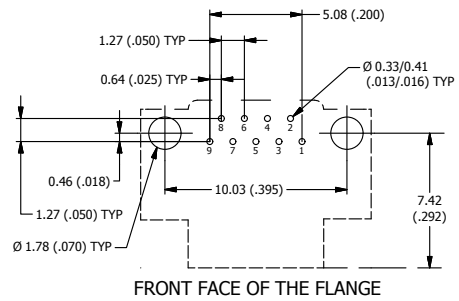

## 15 CONTACTS - VIEW A

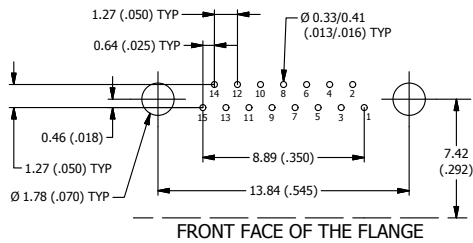

## 21 CONTACTS - VIEW A

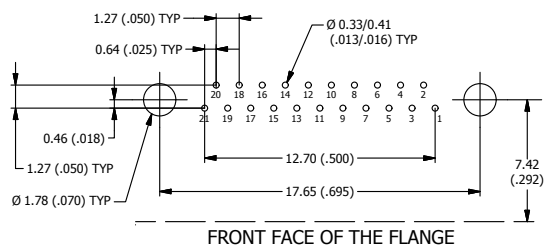

## 25 CONTACTS - VIEW A

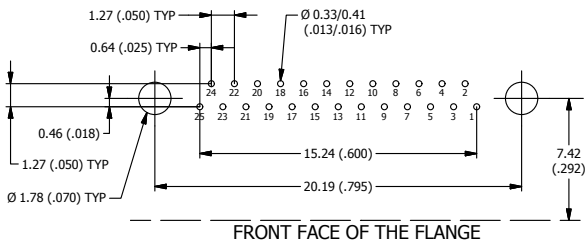

## 31 CONTACTS - VIEW A

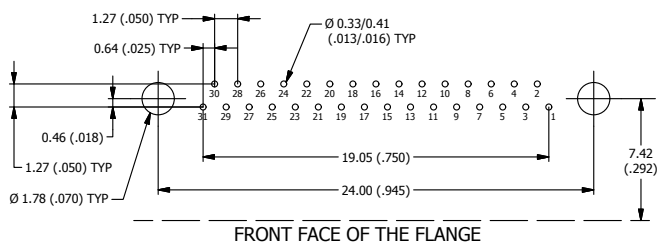

## 37 CONTACTS - VIEW A

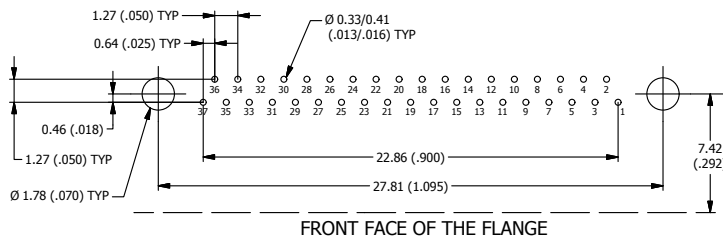

## 51 CONTACTS - VIEW A

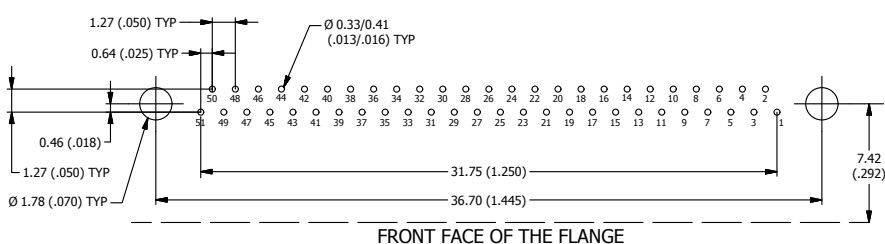

# PCB LAYOUT FOR SMV TYPE 0.025" PITCH - FEMALE CONNECTORS

VIEW A

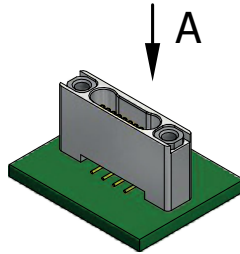
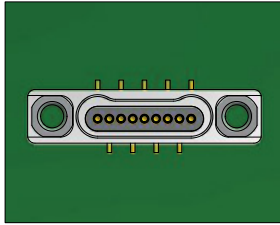

9 CONTACTS - VIEW A

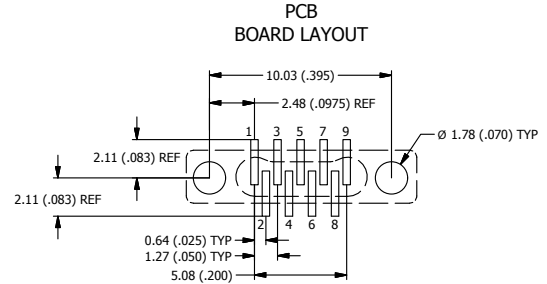

15 CONTACTS - VIEW A

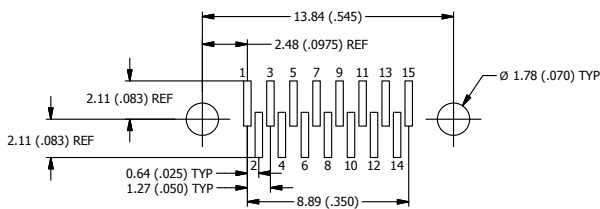

21 CONTACTS - VIEW A

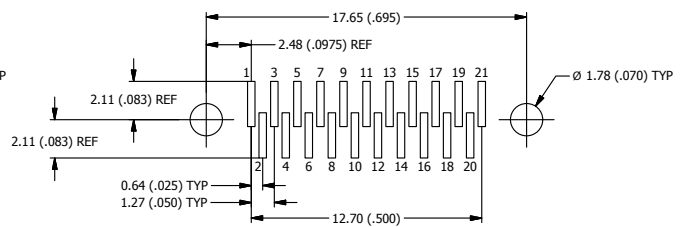

25 CONTACTS - VIEW A

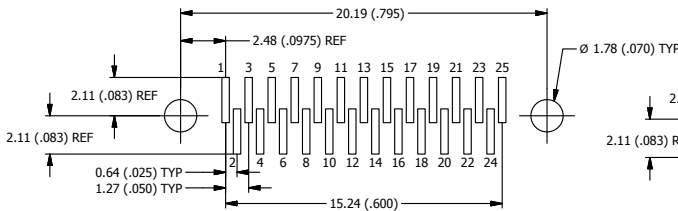

31 CONTACTS - VIEW A

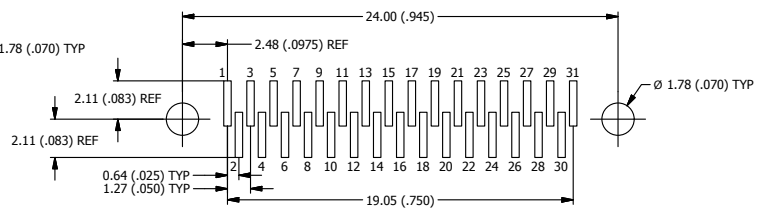

37 CONTACTS - VIEW A

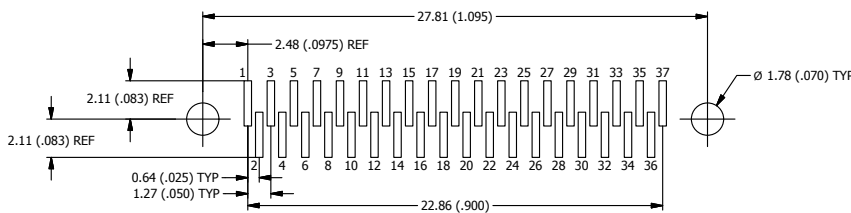

LAYOUT

FOOTPRINT/PAD configuration

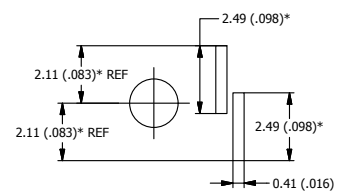

\*: For .040" tail length, add .020" to noted dimensions

51 CONTACTS - VIEW A

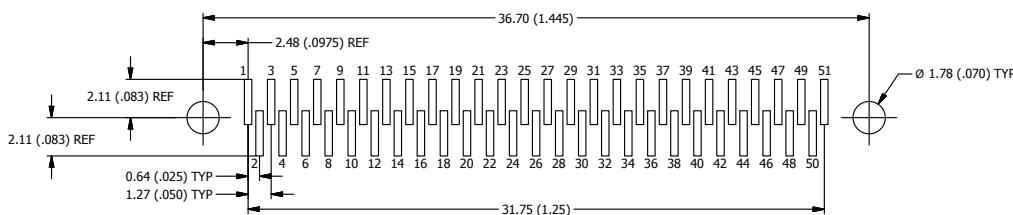

# PCB LAYOUT FOR SMV TYPE 0.025" PITCH - MALE CONNECTORS

VIEW A

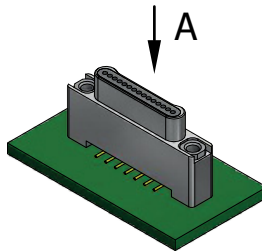
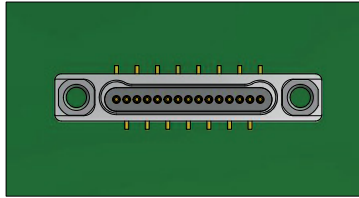

9 CONTACTS - VIEW A

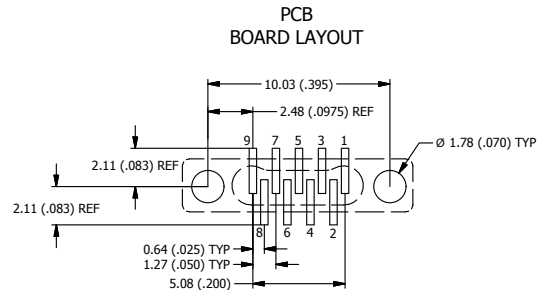

15 CONTACTS - VIEW A

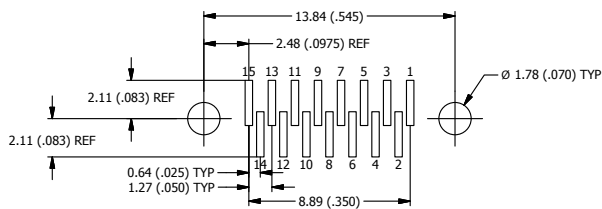

21 CONTACTS - VIEW A

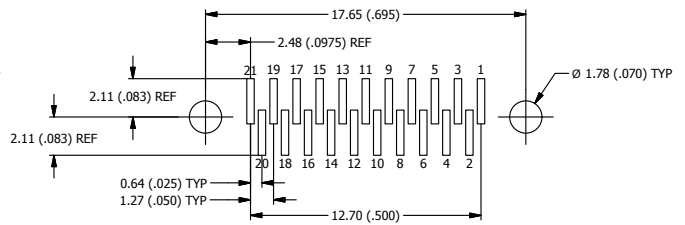

25 CONTACTS - VIEW A

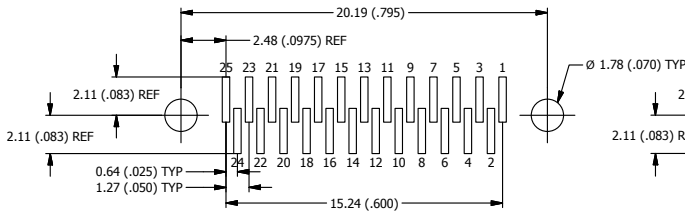

31 CONTACTS - VIEW A

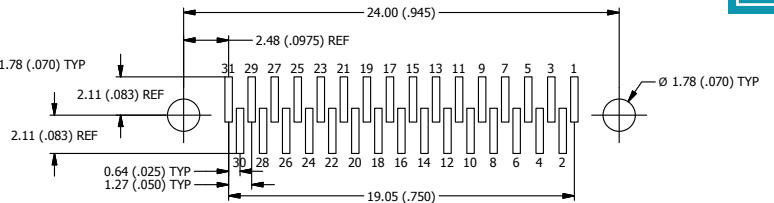

37 CONTACTS - VIEW A

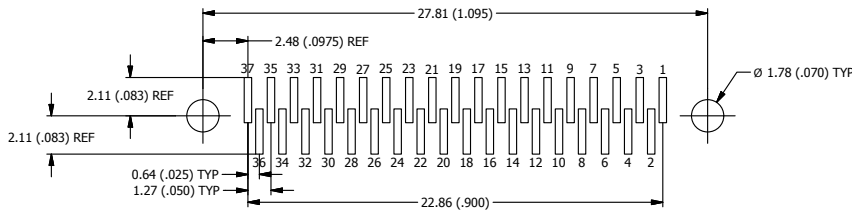

51 CONTACTS - VIEW A

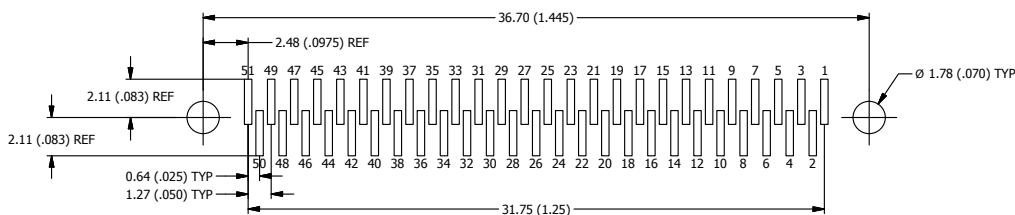

LAYOUT

FOOTPRINT/PAD configuration

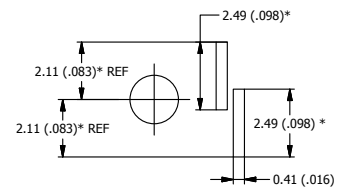

\*: For .040" tail length, add .020" to noted dimensions

SINGLE ROW  
NANO-D CONNECTORS

Nano-D  
connectors

# PCB LAYOUT FOR SMH TYPE 0.025" PITCH - FEMALE CONNECTORS

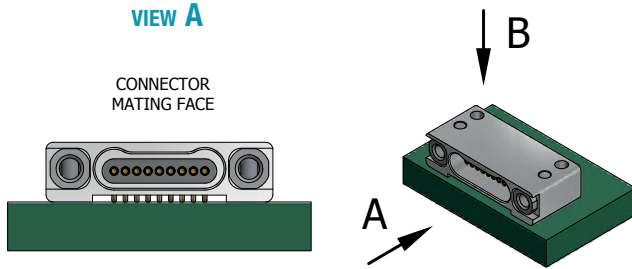

**9 CONTACTS - VIEW A**

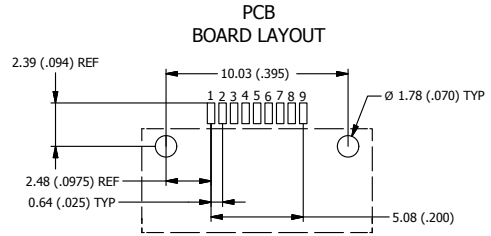

**15 CONTACTS - VIEW A**

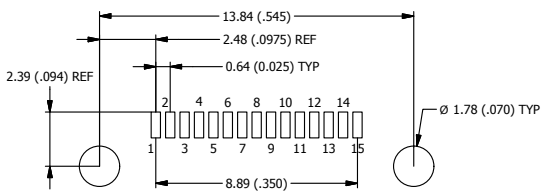

**21 CONTACTS - VIEW A**

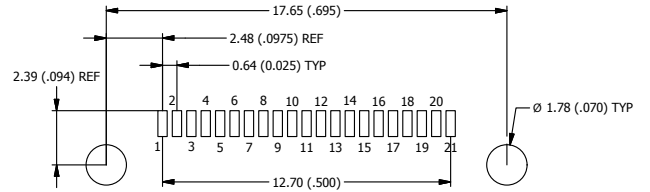

**25 CONTACTS - VIEW A**

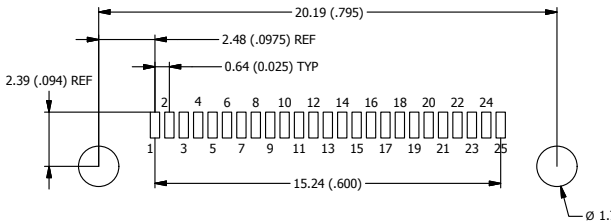

**31 CONTACTS - VIEW A**

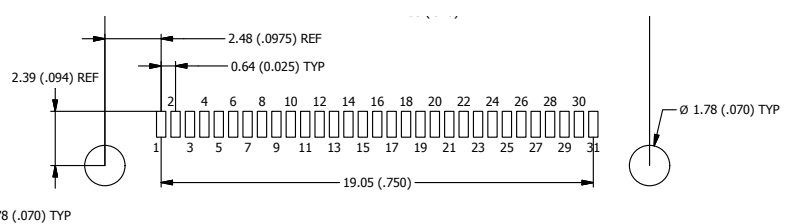

**37 CONTACTS - VIEW A**

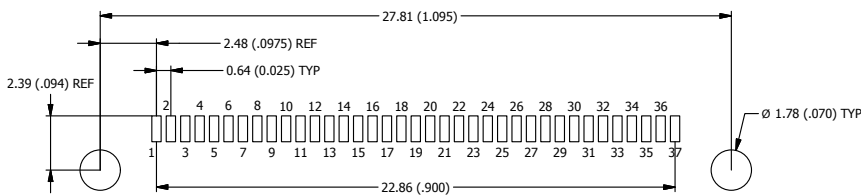

**LAYOUT**

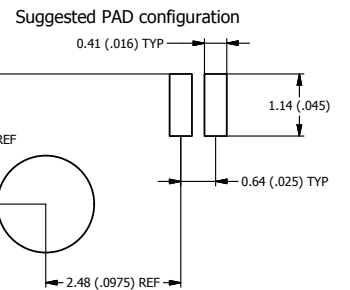

**51 CONTACTS - VIEW A**

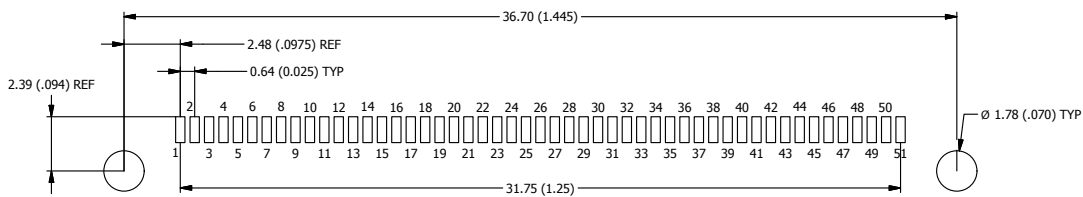

# PCB LAYOUT FOR SMH TYPE 0.025" PITCH - MALE CONNECTORS

VIEW A

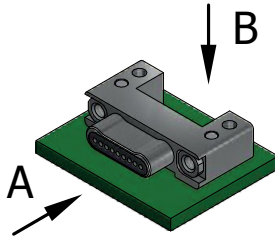
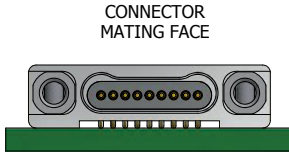

9 CONTACTS - VIEW A

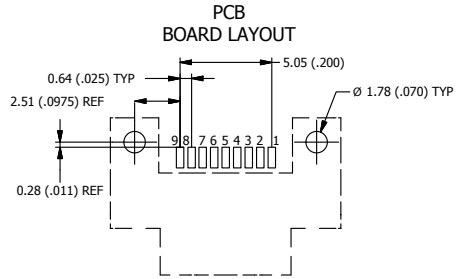

15 CONTACTS - VIEW A

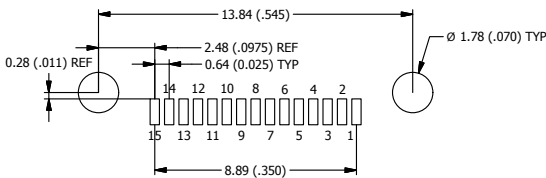

21 CONTACTS - VIEW A

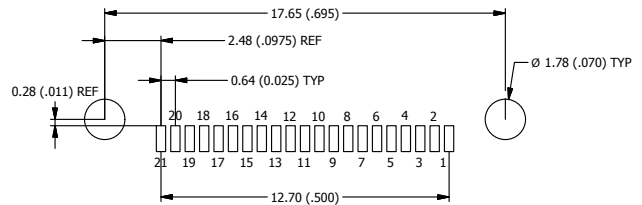

25 CONTACTS - VIEW A

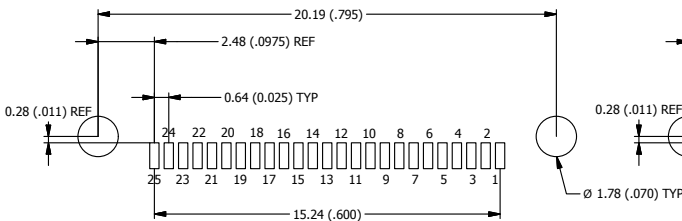

31 CONTACTS - VIEW A

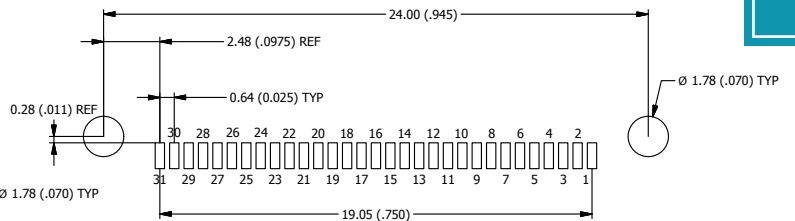

37 CONTACTS - VIEW A

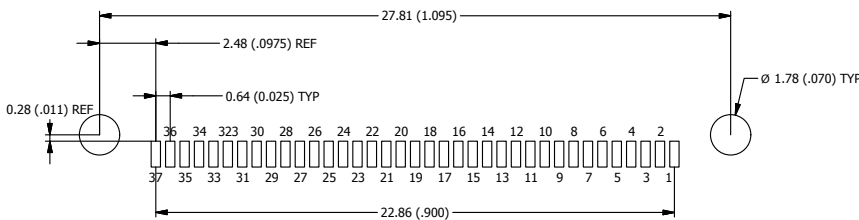

LAYOUT

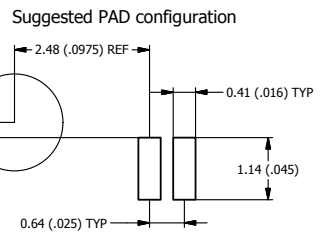

51 CONTACTS - VIEW A

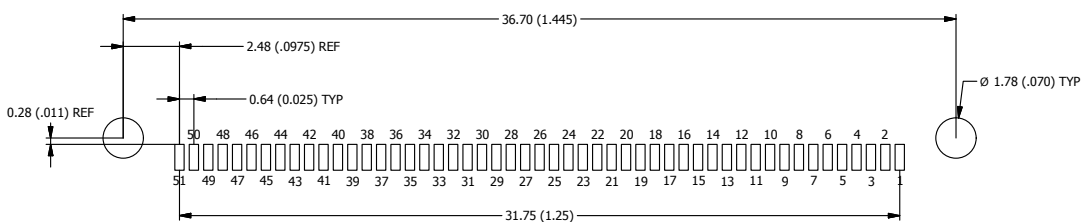

SINGLE ROW  
NANO-D CONNECTORS

Nano-D  
connectors

*Nano-D*  
*connectors*

# HIGH DENSITY CONNECTORS

- High density connectors ..... 282
- General characteristics ..... 283
- Pigtail connectors ..... 284
- PCB connectors ..... 286
  - Board straight type (BS) 0.050" pitch dimensions* ..... 287
  - PCB layout for BS type* ..... 288
  - Condensed board right (CBR) 0.050" pitch dimensions* ..... 289
  - PCB layout for CBR type* ..... 290



HIGH DENSITY  
MICRO-D CONNECTORS

Nano-D  
connectors

# HIGH DENSITY CONNECTORS

## NANO-D PITCH

As the need for increased miniaturisation is becoming even greater, AXON' has developed an ultra-high density solution within the existing micro connector size. By putting nano contacts and nano pitch spacing into an existing micro shell, extremely compact connectors with very high pin counts can be produced in circular, rectangular, plastic and metal forms.

Optimal cabling density is achieved in a rectangular ultra high density connector made with Nano-D contacts and spacing inside a standard Micro-D shell size. Such a connector can accommodate a very large amount of pins while retaining excellent Micro-D reliability.

Most electrical and environmental performances are comparable to those of standard Nano-D connectors (250 V<sub>AC</sub>, 200°C), combined with the robustness and shielding efficiency of the Micro-D metal shell which is compatible with all the hardware types available for Micro-D pigtailed.

This same process can be applied to most of the standard and special Micro-D range, making it possible to have ultra high density versions of PCB connectors, wide flange versions, circular, rectangular and combo style versions with a mix of Micro-D and Nano-D contacts.



▲ RECTANGULAR HIGH DENSITY MICRO-D CONNECTORS

## ► Contact arrangements

### MATING FACE OF MALE CONNECTOR

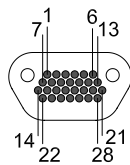

### MATING FACE OF FEMALE CONNECTOR

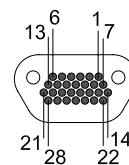

### 28 NANO WAYS IN A 9 WAY MICRO INSERT

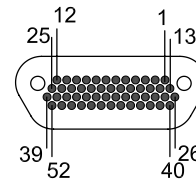
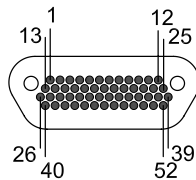

### 52 NANO WAYS IN A 15 WAY MICRO INSERT

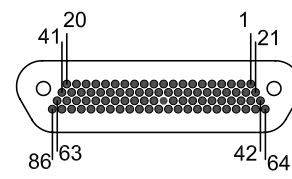
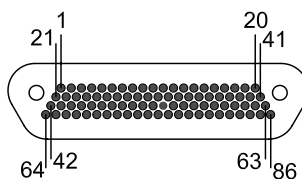

### 86 NANO WAYS IN A 25 WAY MICRO INSERT



# GENERAL CHARACTERISTICS

## ► Electrical & mechanical characteristics

CHARACTERISTIC	SPECIFICATION	TEST METHOD
CURRENT RATING	1 A max.	EIA-364-70
SIGNAL CONTACT RESISTANCE	71 mΩ max.	EIA-364-06
INSULATION RESISTANCE	5000 MΩ min. @ 100 V <sub>dc</sub>	EIA-364-21
DIELECTRIC WITHSTANDING VOLTAGE - SEA LEVEL 0 m - ALTITUDE 21 km (70,000 ft)	250 V <sub>ac</sub> 100 V <sub>ac</sub>	EIA-364-20
CONTACT ENGAGING AND SEPARATION FORCE	141 g max. (5 oz) 11 g min. (0.4 oz)	EIA-364-37
CONNECTOR MATING AND DE-MATING FORCE	198 g (7 oz) x number of contacts max.	EIA-364-13
CONTACT RETENTION	0.9 kg (2 lbs) for 5 seconds min.	EIA-364-29
DURABILITY	200 mating cycles min.	EIA-364-09
TEMPERATURE RANGES - STANDARD - HIGH TEMP	-55°C / +150°C -55°C / +200°C	
VIBRATION	20 g's - No discontinuity >1μs	EIA-364-28 - TEST CONDITION IV
SHOCK	100 g's - No discontinuity >1μs	EIA-364-27 - TEST CONDITION G
SALT SPRAY	48 hours	EIA-364-26 - TEST CONDITION B
HUMIDITY	Insulation resistance > 1MΩ	EIA-364-31 - TEST CONDITION B (EXCLUDING STEPS 7A & 7B)*

## ► Material & Finish

COMPONENT	MATERIAL	FINISH
MALE CONTACT (TWIST PIN)	PRECIOUS GOLD ALLOY IN ACCORDANCE WITH ASTM-B-477 OR 541 OR 562	NONE
FEMALE CONTACT	PRECIOUS GOLD ALLOY IN ACCORDANCE WITH ASTM-B-477 OR 541 OR 562	NONE
	COMMERCIAL BRONZE IN ACCORDANCE WITH ASTM-B-135, B-140/140M, B-372 OR B-587  BRASS IN ACCORDANCE WITH ASTM-B-453 OR 453M OR 16 OR 16M	GOLD PLATING IN ACCORDANCE WITH ASTM-B488, TYPE II, CLASS 1 (1.27μm MIN. (0.00005")), CODE C OVER NICKEL UNDERPLATE IN ACCORDANCE WITH SAE-AMS-QQ-N-290, CLASS 2 (1.27μm (0.00005") TO 3.81μm (0.00015"))
METAL SHELL	ALUMINIUM ALLOY, TYPE 6061	ELECTROLESS NICKEL PLATING IN ACCORDANCE WITH SAE-AMS-2404, CLASS 4. BLACK ZINC NICKEL OVER NICKEL UNDERPLATE
	STAINLESS STEEL 300 SERIES	PASSIVATION IN ACCORDANCE WITH SAE-AMS2700
INSERT/ PCB TRAY	LIQUID CRYSTAL POLYMER, 30% LOADED GLASS FIBRE POLYESTER 94VO, IN ACCORDANCE WITH MIL-M-24519 (200°C) OR PEEK	
HARDWARE	STAINLESS STEEL, 300 SERIES	PASSIVATION IN ACCORDANCE WITH SAE-AMS2700
ENCAPSULANT	EPOXY RESIN	
INSULATED WIRE	PTFE INSULATED SILVER PLATED COPPER IN ACCORDANCE WITH NEMA-HP3	
UNINSULATED WIRE	GOLD PLATED SOLID COPPER WIRE IN ACCORDANCE WITH A-A-59551 OR GOLD PLATED SOLID COPPER BASED ALLOY IN ACCORDANCE WITH ASTM-B-194	GOLD PLATING IN ACCORDANCE WITH ASTM-B488, TYPE II, CLASS 1 (1.27μm MIN. (0.00005")), CODE C OVER NICKEL UNDERPLATE IN ACCORDANCE WITH SAE-AMS-QQ-N-290, CLASS 2 (1.27μm (0.00005") TO 3.81μm (0.00015"))

\*\* ACCORDING TO MIL-DTL-32139

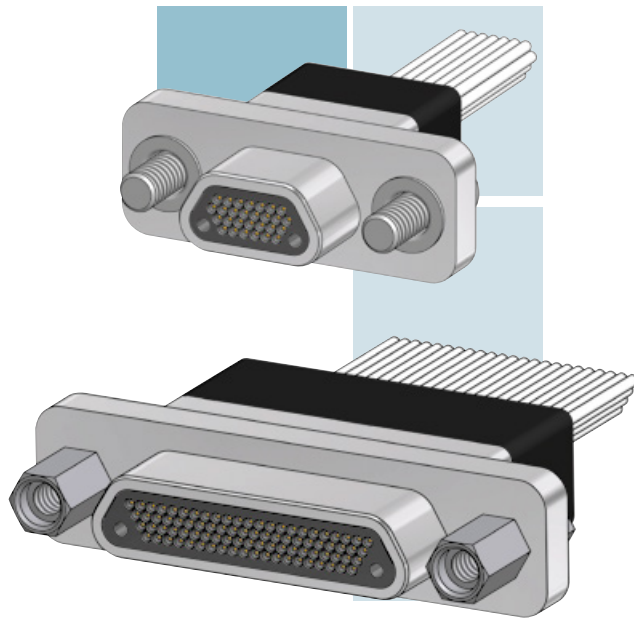

# PIGTAIL CONNECTOR

## METAL SHELL

- High performance metal connector and PTFE wires
- Operating temperature: 150°C or 200°C
- 28 to 86 contacts

## IDENTIFICATION CODE

**MDHDA 2 52 P 1 L 050 L**

### SERIES

**MDHDA:** Micro-D High Density AXON®.

### CONNECTOR TYPE

- 1:** Cadmium al. shell / **Z:** Black zinc nickel aluminium shell + potting 150°C.  
**2:** Nickel aluminum shell + potting 150°C.  
**3:** Nickel aluminum shell + potting 200°C.  
**S:** Passivated stainless steel shell + potting 200°C.

### NUMBER OF CONTACTS

**28, 52, 86.**

See page 282 for contact arrangements.

### CONNECTOR GENDER

- P:** Male (pin contacts).  
**S:** Female (socket contacts).

### WIRE TYPE

- 1:** UT3007, AWG 30, 7 strands, 160V.  
**2:** ET3207, AWG 32, 7 strands, 250V.  
**3:** ET3407, AWG 34, 7 strands, 250V.  
**4:** ET3607, AWG 36, 7 strands, 250V.

### COLOUR CODE

- L:** All white.  
**F:** All yellow.  
**W:** 10 colour repeat.  
 See page 215 for colour code.

### WIRE LENGTH (in cm)

Attention! Wire length in centimetres - (1cm = 10mm = 0.394").

L	L ≤ 10	10 < L ≤ 100	L > 100
in cm (inches)	L ≤ 3.940	3.940 < L ≤ 39.40	L > 39.40
TOLERANCE	-0 / +0.5	-0 / +3	-0 / +5
in cm (inches)	-0 / +0.200	-0 / +1.180	-0 / +1.970

### HARDWARE

- B:** No hardware.  
**C:** U-clips with low profile hex socket head jackscrews (removable).  
**D:** U-clips with low profile slot head jackscrews (removable).  
**M:** Low profile socket hex head jackscrews (removable).  
**N:** High profile socket hex head jackscrews (removable).  
**S:** Low profile slot head jackscrews (removable).  
**T:** High profile slot head jackscrews (removable).  
**P:** Jackposts (removable).  
**Px** (x: 1 to 5): Panel mount jackposts.  
**K:** High profile slot head jackscrews (non removable).  
**L:** Low profile socket hex head jackscrews (non removable).  
**F:** Float mount (non removable).  
**FR:** Float mount, rear panel mount (non removable).  
 See pages 190 to 200 for hardware description.

## DIMENSIONS

Dimensions are in millimetres (inches).



▲ PIGTAIL 28 WAY PLUG

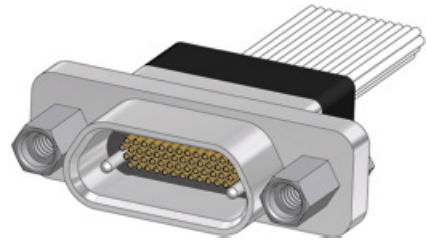

▲ PIGTAIL 52 WAY RECEPTACLE

### MALE connector

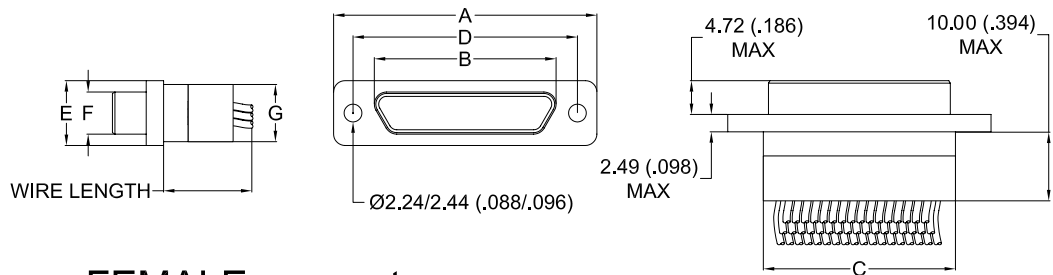

### FEMALE connector

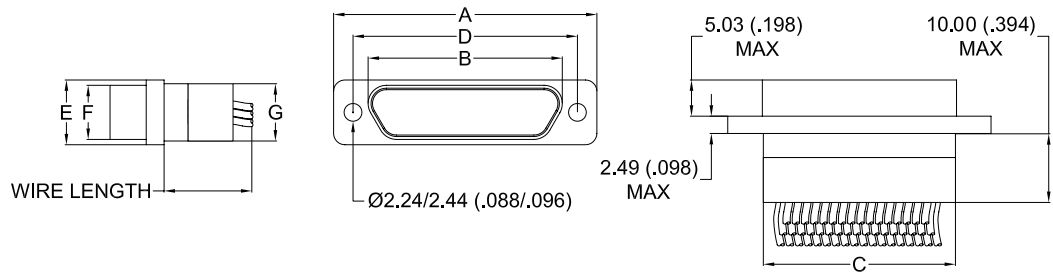

	A ±0.25 (±.010)	B max.		C - 0.46/+0.25 (-.018/+.010)	D ±0.13 (±.005)	E ±0.25 (±.010)	F max.		G max.
		Male	Female				Male	Female	
28 P / 28 S	19.69 .775	8.48 .334	10.16 .400	9.91 .390	14.35 .565	7.57 .298	4.69 .185	6.35 .250	6.86 .270
52 P / 52 S	23.50 .925	12.29 .484	14.00 .551	13.72 .540	18.16 .715	7.57 .298	4.69 .185	6.35 .250	6.86 .270
86 P / 86 S	29.85 1.175	18.64 .734	20.35 .801	20.07 .790	24.51 .965	7.57 .298	4.69 .185	6.35 .250	6.86 .270

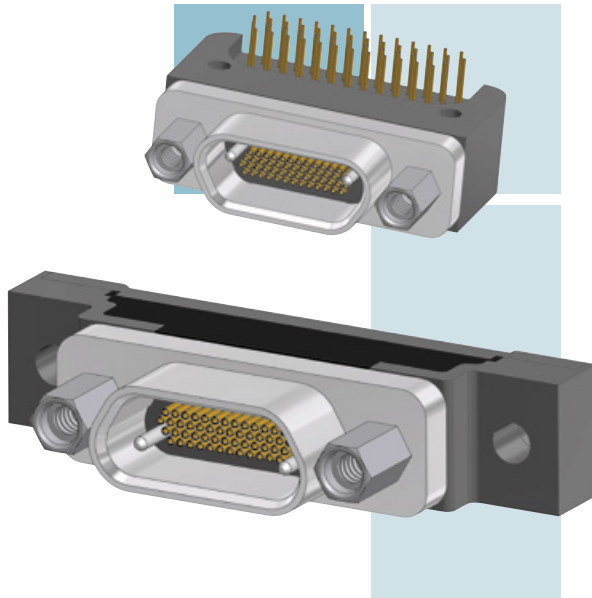

# PCB CONNECTOR

## 0.050" PITCH

### METAL SHELL

- Board Straight connector and Board Right angle connector for flexible and rigid printed circuit board
- Operating temperature: 150°C or 200°C
- Several tail lengths available

## IDENTIFICATION CODE

MDHDA	2	52	S	BS	W	G	1
-------	---	----	---	----	---	---	---

### SERIES

**MDHDA:** Micro-D High Density AXON®.

### CONNECTOR TYPE

- 1:** Cadmium aluminum shell / **Z:** Black zinc nickel shell + potting 150°C.  
**2:** Nickel aluminum shell + potting 150°C.  
**3:** Nickel aluminum shell + potting 200°C.

### NUMBER OF CONTACTS

**28, 52, 86.**

*See page 282 for contact arrangements.*

### CONNECTOR GENDER

- P:** Male (pin contacts).  
**S:** Female (socket contacts).

### PCB VERSION

- BS:** Board Straight connector 0.050" pitch.  
**CBR:** Condensed Board Right Angle connector 0.050" pitch.

### HARDWARE

- B:** No hardware.  
**P:** Jackposts (non removable).  
**Px** (x: 1 to 5): Panel mount jackposts.  
**T:** Threaded inserts installed.  
**W:** Jackpost and threaded inserts installed.  
**Wx** (x: 1 to 5): Panel mount jackposts and threaded inserts installed.  
*See pages 190 to 200 for hardware description.*

### CONDUCTOR TYPE

- G:** Gold plated solid conductor AWG30.

### TAIL LENGTH

- 1:** 2.80mm (0.110").  
**2:** 3.80mm (0.150").  
**3:** 4.80mm (0.190").  
*Tolerance: ± 0.25 mm (0.010").*

# BOARD STRAIGHT TYPE (BS) 0.050" PITCH

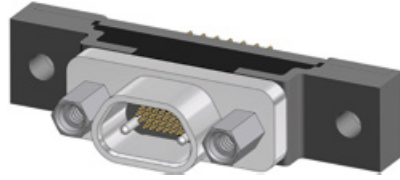

▲ BS 0.050" 28 WAY RECEPTACLE

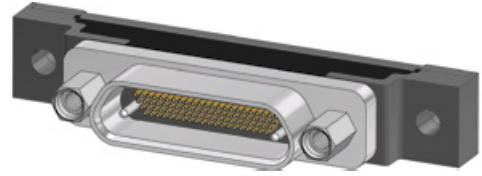

▲ BS 0.050" 86 WAY RECEPTACLE

## DIMENSIONS

Dimensions are in millimetres (inches).

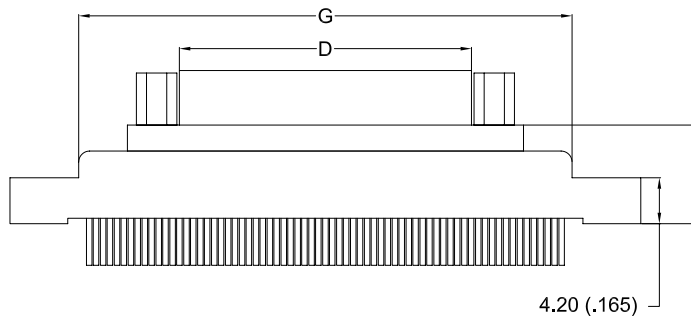
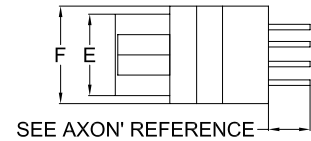
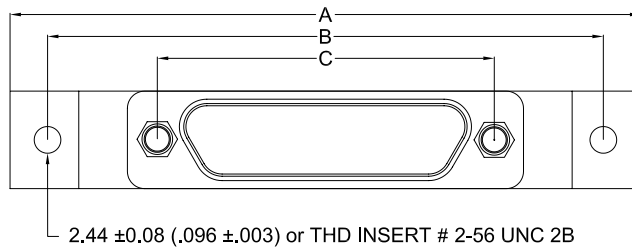

	A max.	B ±0.18 (±.007)	C ±0.13 (±.005)	D max.		E max.		F max.	G max.	H max.
				Male	Female	Male	Female			
28 P / 28 S	35.31 1.390	29.21 1.150	14.35 .565	8.48 .334	10.16 .400	4.69 .185	6.35 .250	7.82 .308	19.94 .785	9.02 .355
52 P / 52 S	35.31 1.390	29.21 1.150	18.16 .715	12.29 .484	14.00 .551	4.69 .185	6.35 .250	7.82 .308	24.00 .945	9.02 .355
86 P / 86 S	44.20 1.740	38.10 1.500	24.51 .965	18.64 .734	20.35 .801	4.69 .185	6.35 .250	7.82 .308	32.39 1.275	9.02 .355

# PCB LAYOUT FOR HIGH DENSITY BS TYPE 0.050" PITCH CONNECTORS

CONNECTOR  
MATING FACE

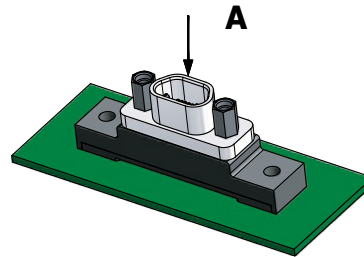
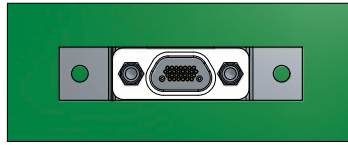

## MALE CONNECTORS

### 28 CONTACTS - VIEW A

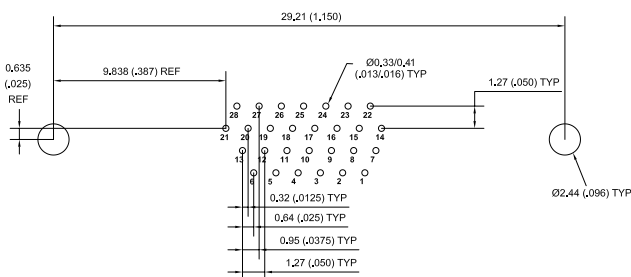

### 52 CONTACTS - VIEW A

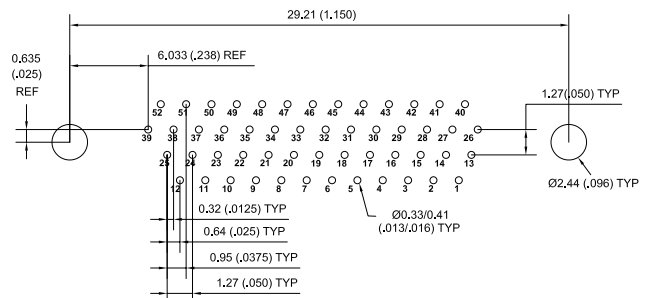

### 86 CONTACTS - VIEW A

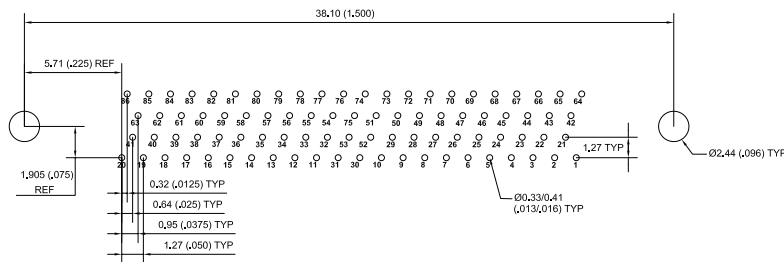

## FEMALE CONNECTORS

### 28 CONTACTS - VIEW A

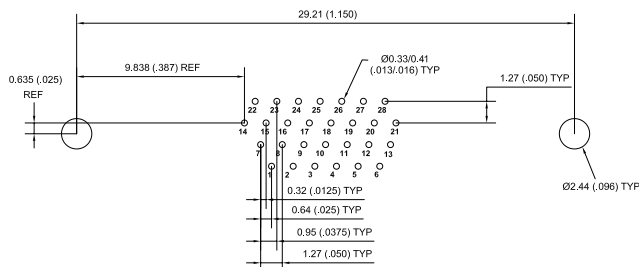

### 52 CONTACTS - VIEW A

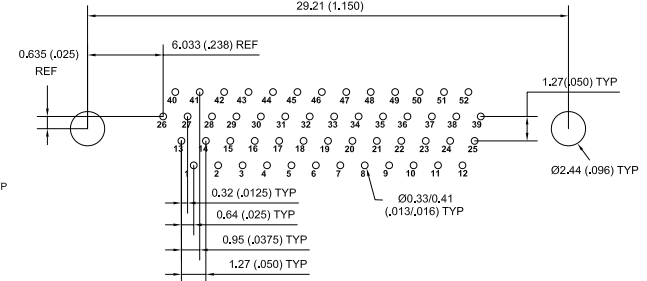

### 86 CONTACTS - VIEW A

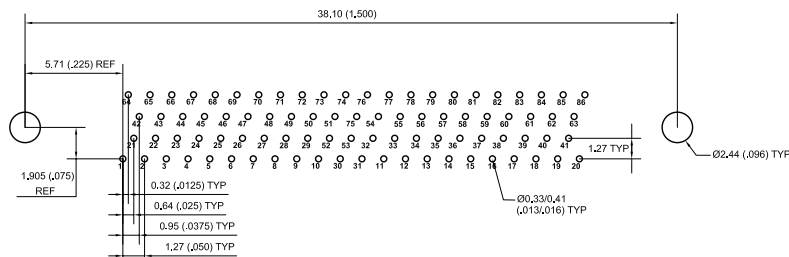

# CONDENSED BOARD RIGHT (CBR) 0.050" PITCH

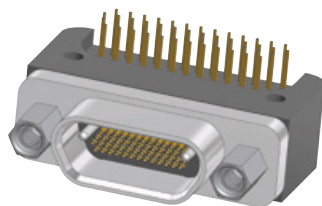

▲ CBR 0.050" 52 WAY RECEPTACLE



▲ CBR 0.050" 86 WAY RECEPTACLE

## DIMENSIONS

Dimensions are in millimetres (inches).

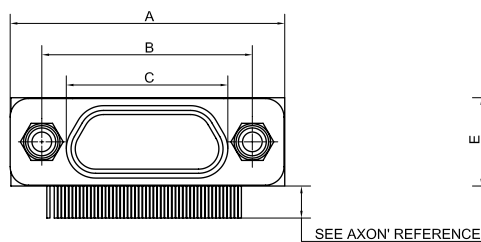

28 - 52 way connectors

86 way connector

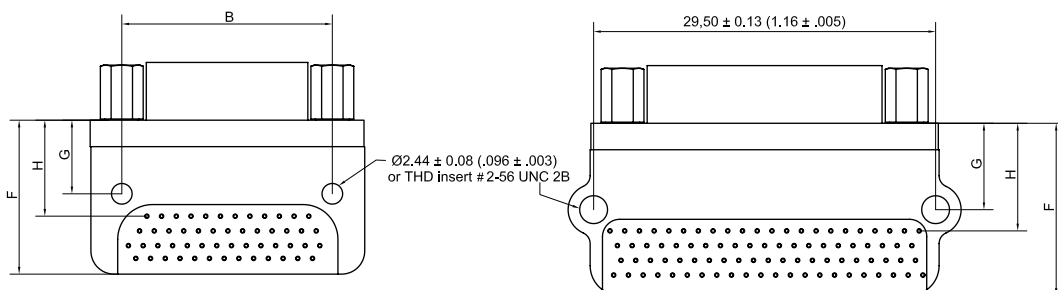

	A max.	B $\pm 0.13$ ( $\pm 0.005$ )	C max.		D max.		E max.	F max.	G $\pm 0.25$ ( $\pm 0.010$ )	H $\pm 0.25$ ( $\pm 0.010$ )
			Male	Female	Male	Female				
28 P / 28 S	19.94 .785	14.35 .565	8.48 .334	10.16 .400	4.69 .185	6.35 .250	7.82 .308	13.50 .532	6.35 .250	7.81 .308
52 P / 52 S	23.75 .935	18.16 .715	12.29 .484	14.00 .551	4.69 .185	6.35 .250	7.82 .308	13.50 .532	6.35 .250	8.28 .326
86 P / 86 S	30.10 1.185	24.51 .965	18.64 .734	20.35 .801	4.69 .185	6.35 .250	7.82 .308	15.00 .590	7.45 .293	9.28 .365

# PCB LAYOUT FOR HIGH DENSITY CBR TYPE 0.050" PITCH CONNECTORS

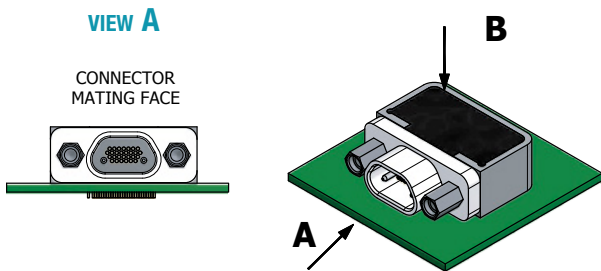

## MALE CONNECTORS

### 28 CONTACTS - VIEW B

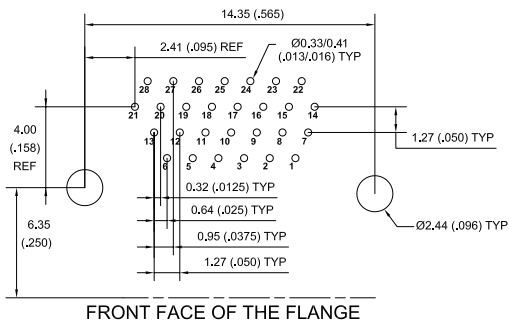

FRONT FACE OF THE FLANGE

### 52 CONTACTS - VIEW B

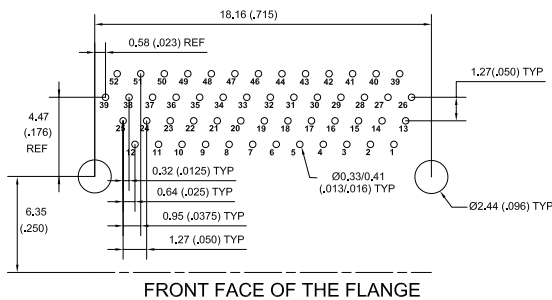

FRONT FACE OF THE FLANGE

### 86 CONTACTS - VIEW B

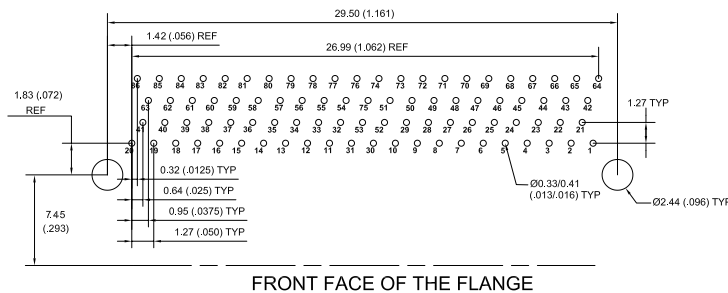

FRONT FACE OF THE FLANGE

## FEMALE CONNECTORS

### 28 CONTACTS - VIEW B

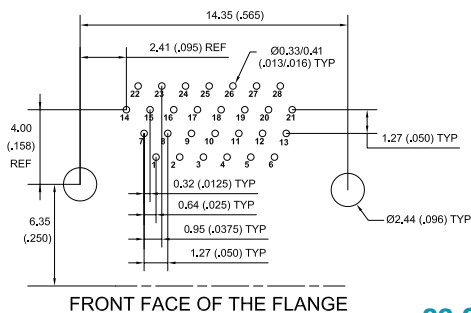

FRONT FACE OF THE FLANGE

### 52 CONTACTS - VIEW B

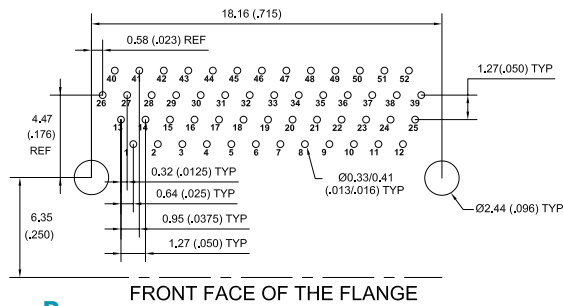

FRONT FACE OF THE FLANGE

### 86 CONTACTS - VIEW B

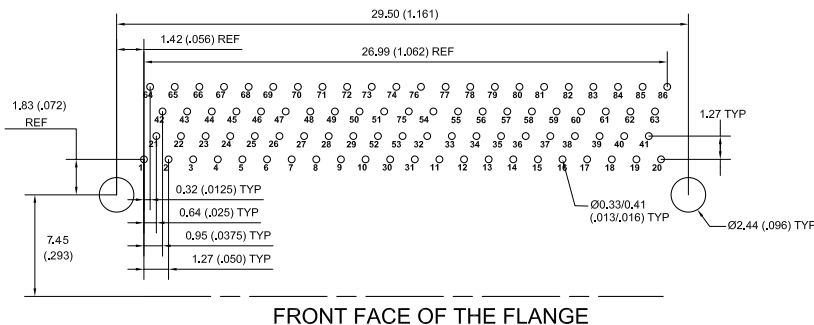

FRONT FACE OF THE FLANGE